

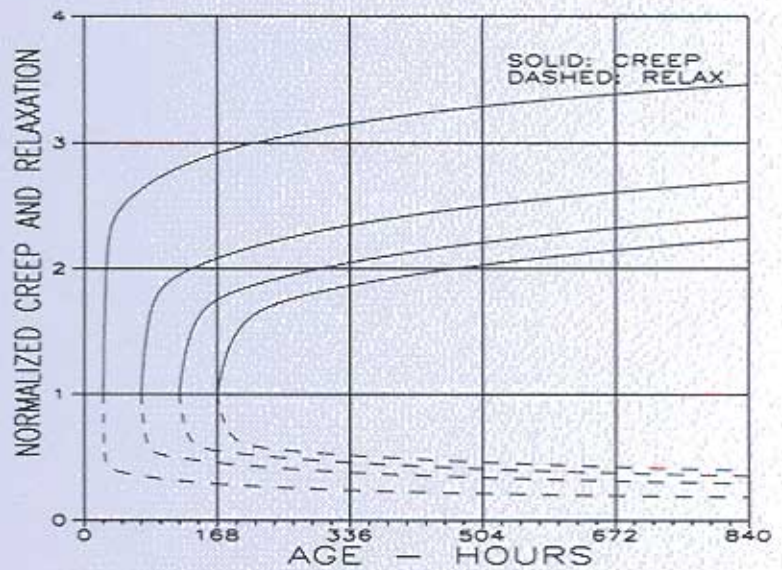

HETEK

Control of Early Age Cracking in Concrete
Phase 4B: Material Modelling –
Composite Approach



Report No.112
1997



Road Directorate Denmark
Ministry of Transport

IRRD Information

Title in English **HETEK -Control of Early Age Cracking in Concrete - Phase 4B: Material Modelling - Composite Approach**

Title in Danish **HETEK -Styring af revner i ung beton - Fase 4B: Materialemodellering, Kompositteoretisk fremgangsmåde**

Authors Lauge Fuglsang Nielsen

Subject classification Field 32 Concrete

Key words

Concrete	4755
Analysis	7152
Material (constr)	4555
Numerical	6432
Properties	5925
Thermal stress in material	5575
Denmark	8028

Abstract A composite-rheological model of concrete is presented by which consistent predictions of creep, relaxation and internal stresses can be made in one approach from known concrete composition. The usefulness of the model is demonstrated by comparison of predictions with results from HETEK, phase 2 and 3 with results from the literature.

UDK 691.32
620.191.33

ISSN 0909-4288

ISBN 87-7491-825-7

Preface

This project on control of early age cracking is part of the Danish Road Directorate's research programme, High Performance Concrete - The Contractor's Technology¹, abbreviated to HETEK.

In this programme high performance concrete is defined as concrete with a service life in excess of 100 years in an aggressive environment.

The research programme includes investigations concerning the contractor's design of high performance concrete and execution of the concrete work with reference to the required service life of 100 years.

The total HETEK research programme is divided into segments parts with the following topics:

- chloride penetration
- frost resistance
- control of early-age cracking
- curing (evaporation protection)
- trial casting
- repair of defects.

The Danish Road Directorate invited tenders for this research programme which is mainly financed by the Danish Ministry for Commerce and Industry - The Commission of Research and Development Contracts.

The present report refers to the part of the HETEK project which deals with control of early age cracking.

For durability reasons reinforced structural members should be well protected against penetration of water, chloride etc. This means that cracks should be avoided or at least the crack-width limited. Formation of cracks can take place already during the hardening process. An evaluation of the risk of crack formation involves a stress analysis. In stress analysis of hardening concrete structures, the load consists of the autogenous deformation and the differences in thermal strains that arise from the heat of hydration. The mechanical properties also change during the hardening process. If a stress analysis shows high stresses compared to the tensile strength there is a high risk of crack formation.

The purpose of this project is to investigate these effects and to prepare a guideline regarding Control of Early Age Cracking.

¹ In Danish: Høj kvalitetsbeton - Entreprenørens Teknologi

The project was carried out by a consortium consisting of:

Danish Concrete Institute represented by:

Højgaard & Schultz A/S
Monberg & Thorsen A/S
RAMBØLL
COWI

and

Danish Technological Institute, represented by the Concrete Centre

and

Technical University of Denmark, represented by the Department of Structural Engineering and Materials.

Two external consultants, professor Per Freiesleben Hansen and manager Jens Frandsen, are connected with the consortium.

The present report on Material Modelling, Composite Approach has been carried out at the Technical University of Denmark.

Material Modelling - Composite Approach

HETEK-Report No. xx5(1997)

Composite Analysis of Concrete

Creep, Relaxation, and Eigenstrain/Stress

LAUGE FUGLSANG NIELSEN

DEPARTMENT OF STRUCTURAL ENGINEERING AND MATERIALS
TECHNICAL UNIVERSITY OF DENMARK - DK-2800 LYNGBY

Summary

This report is part of the Danish Road Directorate's research project on "Control of Early Age Cracking" - which, in turn, is part of the major research programme, "High Performance Concrete - The Contractor's Technology (HETEK)", coordinated by the Danish Road Directorate, Copenhagen, Denmark, 1997.

A composite-rheological model of concrete is presented by which consistent predictions of creep, relaxation, and internal stresses can be made from known concrete composition, age at loading, and climatic conditions. No other existing "creep prediction method" offers these possibilities in one approach.

The model is successfully justified comparing predicted results with experimental data obtained in the HETEK-project on creep, relaxation, and shrinkage of very young concretes cured at a temperature of $T \approx 20^\circ\text{C}$ and a relative humidity of $\text{RH} \approx 100\%$. The model is also justified comparing predicted creep, shrinkage, and internal stresses caused by drying shrinkage with experimental results reported in the literature on the mechanical behavior of mature concretes. It is then concluded that the model presented applies in general with respect to age at loading.

From a stress analysis point of view the most important finding in this report is that cement paste and concrete behave practically as linear-viscoelastic materials from an age of approximately 10 hours. This is a significant age extension relative to earlier studies in the literature where linear-viscoelastic behavior is only demonstrated from ages of a few days. Thus, linear-viscoelastic analysis methods are justified from the age of approximately 10 hours.

The rheological properties of plain cement paste are determined. These properties are the principal material properties needed in any stress analysis of concrete. Shrinkage (auto-geneous or drying) of mortar and concrete and associated internal stress states are examples of analysis made in this report. In this context is discussed that concrete strength is not an invariable material property. It is a property the potentials of which is highly and negatively influenced by any damage caused by stress concentrations such as introduced by eigenstrain/stress actions like shrinkage, temperature, and alkali-aggregate reactions.

Based on the overall positive results reported it is suggested that creep functions needed in Finite Element Analysis (FEM-analysis) of structures can be established from computer-simulated experiments based on the model presented - calibrated by only a few real experiments.

© 1997 Lauge Fuglsang Nielsen

Parts of this report may be reproduced, but only with the indication of source: *Lauge Fuglsang Nielsen: "Composite Analysis of Concrete - Creep, Relaxation, and Eigenstrain/stress", HETEK-report No. xx5(1997) on "Material Modelling - Composite Approach", Danish Road Directorate, Copenhagen, Denmark.*

Content

Summary	2
1. Introduction	5
1.1 Outlines	5
1.2 Concrete as a viscoelastic material	5
Assumptions - multi-axial aspects - design accuracy	6
1.3 Modelling of concrete with Burger-models	9
1.4 This report	11
2. Improved creep description of concrete	12
2.1 Concrete as a composite material	13
Reference climate	15
2.2 Creep in general	16
Cement paste and basic paste	18
3. Viscoelastic composite analysis	19
3.1 Eigenstrain of composite	19
3.2 Eigenstresses in composite	20
3.3 Stresses in composite subjected to external stress	21
3.4 Composite strain from external load	21
4. HETEK-experiments versus theory	23
4.1 Introduction	23
Climatic conditions	24
Young's moduli	24
4.2 Deformation of concrete subjected to variable load	25
Discussion	25
Generalization	27
4.3 Autogenous shrinkage	29
Mortar and paste	29
Concrete	31
Discussion	32
Internal stress - crack risks - strength variation	33
4.4 Relaxation of concrete	36
Discussion	36
5. Conclusions	38
Composite analysis of concrete	38
HETEK-creep experiments	38
HETEK-shrinkage experiments	39
HETEK-relaxation experiments	39
Computer simulated creep tests - FEM	39
Future research	40

Structural analysis	41
Appendix A - Generalized viscoelastic models	42
Appendix B - Multi-axial aspects	44
Appendix C - Algorithms	46
Relax-function from creep function	46
Eigenstrain of composite	46
Eigenstresses in composite	47
Stresses in composite subjected to external stress	47
Composite strain from external stress	48
List of notations	49
Literature	51

1. Introduction

1.1 Outlines

This report is part of the Danish Road Directorate's research programme "HE-TEK^{*)} - Control of Early Age Cracking".

Concrete is considered as an aging isotropic viscoelastic composite material. A composite-rheological concept for such materials is presented by which consistent predictions of creep, relaxation, and internal stresses can be made from known concrete composition, age at loading, and climatic conditions. Internal stresses thought of are caused by external load or by eigenstrain/stress actions developed during shrinkage, fire, and alkali-aggregate reactions for example.

The material concept presented and the analytical/numerical procedures derived are the results of a compilation and integration of ideas previously reported by the author in the field of concrete rheology. The list of literature at the end of the report reflects this feature. The major part of references are to the authors own work - and only some other references of immediate interest are included. Full credit, however, to other authors in the field of concrete rheology is given in "own works" listed.

A list of symbols most frequently used in the analysis is presented at the end of this report.

1.2 Concrete as a viscoelastic material

It is generally accepted that concretes older than a couple of days behave approximately as an aging linear viscoelastic material when moderately loaded (less than 50% of strength). This perception of concrete was first formulated by McHenry (1) - although implicitly applied years before by Dischinger (2,3) who made the first and probably the most important step ever made to perform a practical creep analysis of concrete.

The stress-strain relation of aging linear viscoelastic materials can be formulated in three ways as presented in Equation 1 reproduced from (4). Age in general and age at load application are denoted by t and θ respectively. Age dependent material properties are denoted by $p(t)$ and $q(t)$.

^{*)} HETEK is danish abbreviation of "High Performance Concrete - The Contractor's Technology" - a major research programme coordinated by the Danish Road Directorate, Copenhagen, Denmark, 1997.

$$\begin{aligned}
 \sum_{k=0}^N p_k(t) \frac{d^k \sigma}{dt^k} &= \sum_{k=0}^N q_k(t) \frac{d^k \epsilon}{dt^k} && \text{differential representation} \\
 \epsilon &= \int_0^t C[t, \theta] \frac{d\sigma}{d\theta} d\theta && \text{creep integral representation} \\
 \sigma &= \int_0^t R[t, \theta] \frac{d\epsilon}{d\theta} d\theta && \text{relaxation integral representation}
 \end{aligned} \tag{1}$$

The creep function $C(t, \theta)$ and the relaxation function $R(t, \theta)$ have the meanings outlined in Figures 1 and 2. The two functions are related by Equation 2 from which one of the functions can be determined when the other one is known. Viscoelastic characterizations of materials are very often made from experimentally determined creep functions and/or relaxation functions.

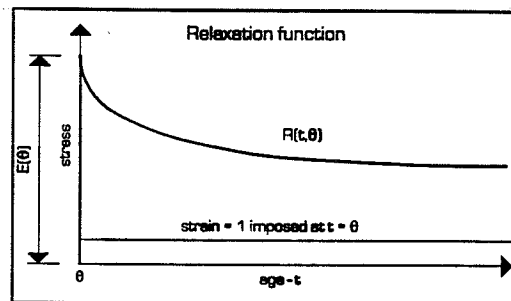
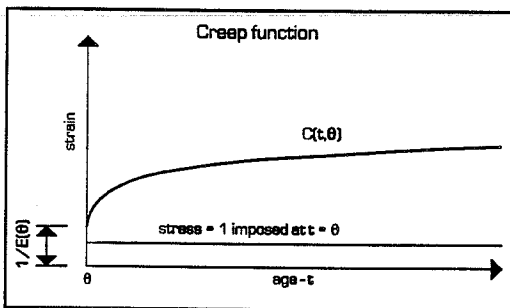

Figure 1. Creep function is strain of material subjected to a constant stress of magnitude 1 applied at $t = \theta$.

Figure 2. Relaxation function is stress in material subjected to a constant strain of magnitude 1 applied at $t = \theta$.

$$\int_0^t C[t, \theta] \frac{dR[\theta, \theta_0]}{d\theta} d\theta = \int_0^t R[t, \theta] \frac{dC[\theta, \theta_0]}{d\theta} d\theta \equiv 1 ; \text{ (loading age: } \theta_0 \text{)} \tag{2}$$

It can be shown that the constitutive equations presented in Equation 1 equal the expressions which relate load and deformation of mechanical models made by combination of springs and dashpots, see Appendix A. Well-known examples are illustrated in Figure 3 with age-dependent spring constants E and viscosities η .

Assumptions - multi-axial aspects - design accuracy

It is assumed in this report that the rheology of concrete in tension is approximately the same as in compression. This assumption reflects a common practice which has been justified experimentally by Ross in (5). It is also assumed that

the shear properties and bulk properties of concrete age in the same way. This means, see Appendix B at the end of this report, that normalized creep functions for shear behavior (subscript G), for bulk behavior (subscript K), and for the uniaxial behavior explained in Figure 1 are the same, meaning that $C_G(t,\theta)/C_G(\theta,\theta) = C_K(t,\theta)/C_K(\theta,\theta) = C(t,\theta)/C(\theta,\theta)$. Materials with such creep behavior are so-called viscoelastic materials with balanced creep. Balanced creep causes creep Poisson's ratios ($v_{CR} = -d\varepsilon_{PERP}(t,\theta)/d\varepsilon_{LONG}(t,\theta)$) to become constants from the age at load application - constants which equal the elastic Poisson's ratios ($v = -\varepsilon_{PERP}(\theta)/\varepsilon_{LONG}(\theta)$) at the age at load application.

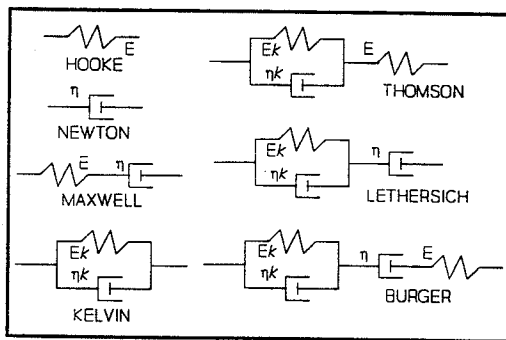

Figure 3. Mechanical analogies to linear viscoelastic materials.

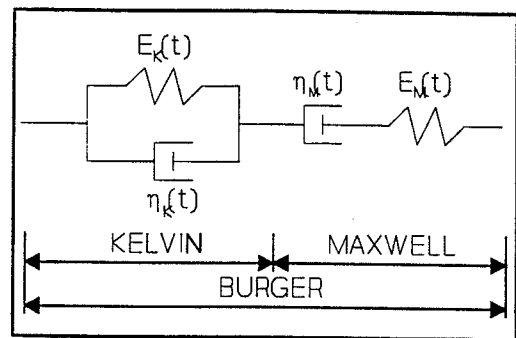

Figure 4. Burger model of aging linear viscoelastic material.

Implicitly the assumption of balanced creep has always been made in practical stress-strain analysis of concrete and concrete structures although the existence of this phenomenon has never been agreed on (or has never been reflected on). It seems that every author who has looked into the problem has his own opinion - or that the phenomenon is so sensitive to concrete composition and measuring technique that it is impossible in practice to present specific answers with respect to the general creep behavior of arbitrary concretes. For example, $v_{CR} = v$ was deduced from experiments by Duke et al. (6) and suggested also by McHenry (1). $v_{CR} = 0$ seems to be the result which can be deduced from experimental data obtained by Ross (5). The results presented in Figures 5 and 6, reproduced from the author's own work (7,8,9) on 3-D analysis of concrete, demonstrate that creep Poisson's ratios can be observed which change from being less than 0 (no less than -1, bulk creep only) to being close to 0.5 (shear creep only). It is noticed that both statements previously referred to, $v_{CR} = v$ and $v_{CR} = 0$, appear section-wise in Figures 5 and 6, meaning that statements on creep Poisson's ratio based on experiments may depend on period of time used in testing.

The experimental data used in Figure 5 and 6 are from tests made by Hummel et al. (10) on longitudinal creep and lateral creep of various concretes subjected

to a uni-axial stress of 10 MPa at the age of $\theta = 28$ days. The solid line in Figure 5 represents data predicted in (8,9) from estimated shear and bulk creep functions.

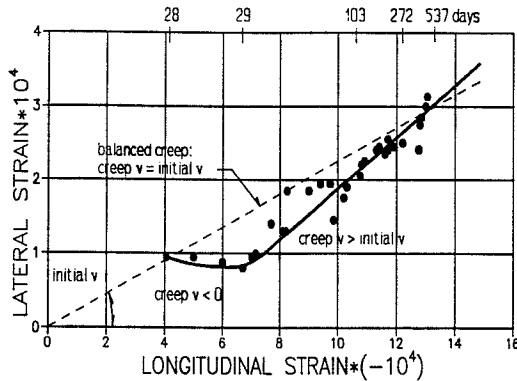

Figure 5. Lateral creep versus longitudinal creep of a granite concrete.

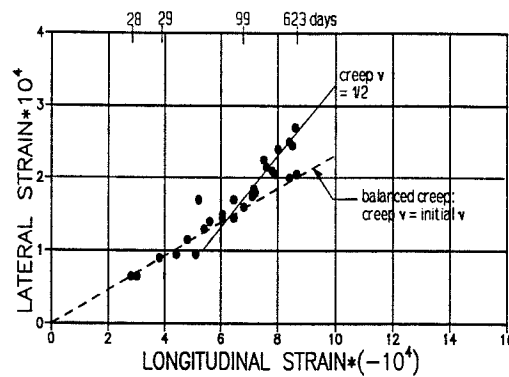

Figure 6. Lateral creep versus longitudinal creep of a basalt concrete.

When insufficient information are available on both creep functions (shear and bulk) the author's suggestion is that the concept of balanced creep is the only assumption which can be made without being too pretentious. The concept is a "coarse average" of observations hitherto made on creep of concrete in general, including the mean of all data put together from Figures 5 and 6. It is at the same time the simplest possible concept which is by no means a disadvantage in projects (like the HETEK-project considered in this report) where practicable methods of analysis are principal research targets.

Important: We proceed assuming balanced creep in this report realizing that results obtained with respect to 3-dimensional (3D) analysis are average results valid for an "average concrete". A 3D-analysis of a specific concretes may reveal results which deviate substantially from the average results. An example presented in (9) will illustrate this feature: A concrete cylinder with lateral strain kept constant is loaded at an age of 28 days with an axial stress of 10 MPa. Which lateral stresses develop on the cylinder? The concrete applied is the granite concrete used by Hummel et. al (10) with viscoelastic behavior described in Figure 5. In the author's opinion this behavior represents a typical deviation from balanced creep: Creep Poisson's ratio starts up being ≈ 0 and ends up such that the overall Poisson's ratio, $-\epsilon_{\text{PERP}}/\epsilon_{\text{LONG}}$, equals the initial Poisson's ratio after a long time.

The answers to the question formulated above are as follows if an analysis is made where balanced creep is not assumed: 2.9 MPa at the age of 28 days, somewhat lower than 2.9 MPa at ages between 28 days and 100 days, and 3.2 MPa at ages greater than approximately 600 days.

If balanced creep (or no creep) is assumed the answer is 2.9 MPa at any age. Thus, the average solutions (balanced creep) to the problem considered deviate time dependently with approximately $\pm 10\%$ from the more exact 3D-solutions.

To decide if such deviations ($\pm 10\%$) are acceptable they must be considered together with deviations with respect to reproducibility of experiments made to deduce material properties - and with the overall accuracy expectations one might have with respect to design of concrete structures.

In the author's experience, only a very few examples can be mentioned where the assumption of balanced creep is not acceptable. For these few examples (with very high class concrete ingredients specified and with load and climate histories very precisely predicted) information on concrete properties must be deduced from complete 3D-experiments, and the structural design procedures must consider both shear and bulk creep functions. In principles there are no problems in doing so. The mathematical complexity, however, and number of experiments to be made will increase dramatically.

Summary: The concept of balanced creep can be used in practical 3D-analysis of most concretes and concrete structures. It is emphasized, however, that too rigorous conclusions should not be made from the results obtained without simultaneous justifications with respect to actual creep behavior of concrete considered. This "warning" applies also if any part of the uni-axial HETEK-project (37,Ph2+3) is used to deduce other material properties than uni-axial properties from experimental data.

It must be emphasized that this summary is based on the assumption that typical 3D-behavior of a concrete is close to the one illustrated in Figure 5. If the overall Poisson's ratio, $-\varepsilon_{\text{PERP}}/\varepsilon_{\text{LONG}}$, at long times is significantly different from the initial Poisson's ratio, then more serious deviations (than 10%) will appear between accurate results and results predicted on the basis of balanced creep. This can easily be shown by the analysis presented in (9).

Further research on the complete creep behavior of concrete is certainly needed to identify more precisely concretes which behave as postulated.

1.3 Modelling of concrete with Burger-models

Mechanical analogies are extremely useful in experimental research on the visco-elastic properties of materials. Total number of creep and/or relaxation tests to be made can be reduced considerably from estimating mechanical models from a few

number of trend tests - or from general experimental experience already known from the literature. As an example the latter attempt has been used by the author in (4):

It is well-known from the literature that creep of concrete consists of:

- A momentary elastic deformation.
- A delayed elastic deformation (reversible strain). This has very convincingly been shown already by Illston (11) and Glucklich et al. (12).
- A viscous (irreversible) deformation. This has been known since the works of Ditchinger (2,3)

These observations are enough to suggest a Burger model as the basic model for establishing creep functions for concrete. Momentary elastic strain is explained by the free spring, reversible creep strain by the build-in Kelvin model, and the irreversible creep strain by the free dashpot plus "frozen" recovery strain from the former two mechanisms (due to aging).

$$\frac{\eta_K(t)}{E_M(t)} \frac{d^2\sigma}{dt^2} + \left(\frac{d\left(\frac{\eta_K(t)}{E_M(t)}\right)}{dt} + \frac{\eta_K(t)}{\eta_M(t)} + 1 + \frac{E_K(t)}{E_M(t)} \right) \frac{d\sigma}{dt} + \left(\frac{d\left(\frac{\eta_K(t)}{\eta_M(t)}\right)}{dt} + \frac{E_K(t)}{\eta_M(t)} \right) \sigma = \eta_K(t) \frac{d^2\varepsilon}{dt^2} + \left(\frac{d\eta_K(t)}{dt} + E_K(t) \right) \frac{d\varepsilon}{dt} \quad (3)$$

The general differential stress-strain relation for the Burger model shown in Figure 4 is presented in Equation 3 reproduced from (4). Associated creep functions are ε with $\sigma \equiv 1$ introduced. Relaxation functions are σ with $\varepsilon \equiv 1$ introduced. Equation 3 is shown for the sake of curiosity only. Equation 3 is by far too pretentious to be used in practice. And also, the efforts to be used in determining all material properties are obviously disproportionate to what can ever be achieved in accuracy in viscoelastic analysis of coarse building materials such as concrete.

The Burger model, however, has great potentials in modelling the behavior of concrete in practice if we reduce (or modify) the influence of time on some material parameters such that structural analysis can still be made with a degree of accuracy proportionate to what is actually known about the rheological properties (in total service life) of the specific concrete under consideration - which is not always a well specified (and not reinforced) concrete cured under pre-set laboratory conditions. Examples of modified Burger-model analysis have been presented

by the author in (4,13) where creep expressions are suggested for the analysis of mature (older than ≈ 2 weeks) concrete structures. The observation previously made on reversible creep of concrete was used to simplify the rate description of reversible creep. Other creep functions based on Burger models have been presented by the author in (14,15,16). Great efforts are made in these papers to develop easy-to-use creep functions in the analysis of mature concrete structures especially - and also to develop methods for fast estimates in creep analysis.

1.4 This report

A composite-rheological description of concrete viscoelasticity is presented in this report. The method is based on principles put forward in (17,18,19) where concrete is considered as an isotropic composite material made of viscoelastic cement paste and elastic aggregates. The method considers in one approach the viscoelasticity of cement paste, mortar, and concrete as homogeneous materials (continua) - and expressions are given by which the internal stress/strain state can be determined in concrete subjected to various load conditions, including eigen-strain/stress loading such as caused by shrinkage and temperature. The method applies at any age of load application.

2. Improved creep description of concrete

More detailed studies of general information presented in the literature on concrete creep can help us to further improve the creep functions based on Burger models:

- Reversible creep develops substantially more rapidly than irreversible creep does. The rate of development decreases with age. The size of reversible creep is approximately 0.4 of the elastic strain associated. These statements are based on observations made by Illston (11) for example.
- Creep continues to increase - at least for a lifetime. The rate, however, is ever decreasing (20,21). It has often been observed that creep from some time after load application is well described by logarithmic functions of time (21,22, 23) - and also (22,23) that creep functions for different ages of loading tend to become parallel as time proceeds to long times.

It is concluded in (17) that these observations can be used to "construct" concrete creep functions at *reference climatic conditions* (temperature $T \equiv 20^\circ\text{C}$, relative humidity $\text{RH} \equiv 100\%$) as presented in in Equation 4. The former expression C_{REV} describes the elastic + delayed elastic part of creep, while the second expression describes the rate of irreversible creep C_{IRREV} .

$$\begin{aligned}
 C_{\text{REV}}(t,\theta) &= \frac{1}{E(\theta)}(1 + a*h(t,\theta)) && \text{(reversible creep)} \\
 \frac{dC_{\text{IRREV}}(t,\theta)}{dt} &= \frac{1}{F} \frac{1}{t} \left(1 + p \left(\frac{C}{\theta} \right)^q \left(\frac{\theta}{t} \right)^p \right) && \text{(rate of irreversible creep)}
 \end{aligned} \tag{4}$$

E and F denote Young's modulus and flow modulus respectively. $a \approx 0.4$ and $C \approx$ days are the so-called reversible creep factor and the consolidation parameter respectively. $q \approx 1$ and $p \geq q$ are rate powers. $h(t,\theta)$ denotes a function which rapidly varies from 0 to 1.

At reference climatic conditions creep functions can now be written as follows with two creep parameters introduced: A reversible creep parameter denoted by Φ , and an irreversible creep parameter denoted by ϕ . The rapidly developing function $h(t,\theta)$ previously referred to in Equation 4 has been approximated such that $h(t,\theta) = \Phi$.

$$\begin{aligned}
 C(t,\theta) &= \frac{1}{E(\theta)}(1 + a*\Phi) + \frac{1}{F}\phi \quad \text{with creep parameters} \\
 \Phi &= 1 - \left(\frac{\theta}{t} \right)^p \quad ; \quad \phi = \log_E \left(\frac{t}{\theta} \right) + \left(\frac{C}{\theta} \right)^q \Phi
 \end{aligned} \tag{5}$$

Remark: Both reversible creep rate and irreversible creep rate are sensitive to temperature and humidity. In this report we assume that the sensitivity of the latter is large enough in practice to ignore the sensitivity of the former creep rate. In the author's opinion we do not know enough today about the influence of climate on creep to justify other than simple methods to consider this influence.

Based on these statements the influence on creep of climatic conditions is further discussed in Section 2.2 of this report. The following modified derivative of the irreversible creep parameter in Equation 5 is reserved for this purpose with f_c introduced as a so-called climate factor.

$$\frac{d\phi}{dt} = \frac{f_c}{t} \left(1 + p \left(\frac{C}{\theta} \right)^q \left(\frac{\theta}{t} \right)^p \right) \quad (6)$$

2.1 Concrete as a composite material

Until now concrete has been considered as a continuum for which rheological properties has to be determined by experiments. Nothing has been mentioned about concrete composition, meaning that experiments have to be made every time we choose another concrete. In this section concrete is considered as a composite material defined by water-cement ratio and aggregate-cement ratio. By doing so we open the possibility of predicting creep from concrete recipes, reducing considerably the number of experiments to be made. Further advantages of the composite concept are that internal stress analysis can be made of the specific concrete considered such that risk analysis of internal damage can be made.

Concretes with water-cement ratios of $W/C \geq 0.4$ are considered in this report. It is noticed, however, that concretes with $W/C < 0.4$ can be considered just as well by the basic approach developed in (17). Only a few modifications have to be introduced.

The viscoelastic composite analysis of concrete made in (17) introduces the following concept of concrete composition, see Figure 7: Concrete is a three component system made of aggregates of constant volume, a pore phase of *constant volume*, and a basic paste of *constant volume*.

Basic paste is that part of the total cement-water system (so-called paste) which will hydrate 100% and become cement-gel corresponding to an effective $W/C = 0.38$. The pore phase has a volume which equals the volume of so-called capillary pores present when all cement has become cement-gel. In other words: Basic paste starts up being

a liquid suspension of cement grains in plain water. The amount of water corresponds to $W/C = 0.38$. A time dependent, constant volume phase transformation then takes place which stops when all basic paste has become gel solid. The *mechanical properties of a basic paste change along with its phase transformation.*

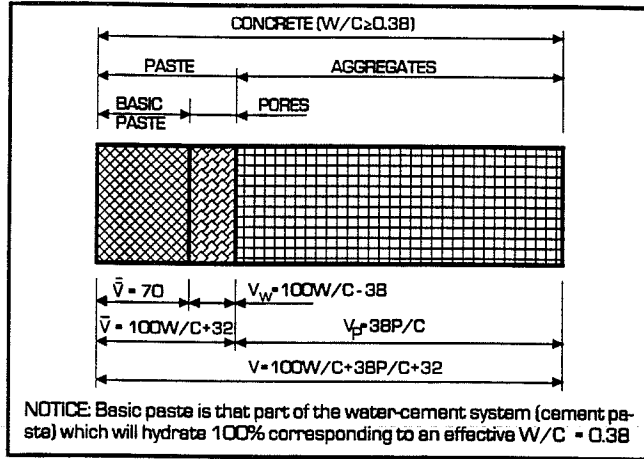

Figure 7. Volume composition of concrete with $W/C \geq 0.38$. Composite system I: Paste = Basic paste + pores. Composite system II: Concrete = Paste + aggregates. The following abbreviations are used: W , C , and P are weights of water, cement, and aggregates respectively. V means volume. Subscripts W and P refer to water and aggregate respectively.

The volume quantities presented in Figure 7 are in cm^3 per 100 gram cement. The volume concentrations associated are presented in Equation 7. The calculations are made with specific weights of cement and aggregates being 3.1 and 2.6 gr/cm^3 respectively. The basic paste occupies a volume which is 2.2 times the volume of cement involved in producing this phase. These specifications are consistent with similar quantities given by Powers and Brownyard in (24).

Composite system I: Paste = Basic paste + pores

$$c_w = \frac{V_w}{V} = \frac{100W/C - 38}{100W/C + 32} \quad (\text{Capillary pores in fully hydrated paste})$$

$$A_w = \left(\frac{1 - c_w}{1 + c_w} \right)^{1.8} = \left(\frac{70}{200W/C - 6} \right)^{1.8} \approx \left(\frac{0.38}{W/C} \right)^{1.8} \quad ("1.8", \text{ see text}) \quad (7)$$

Composite system II: Concrete = Paste + aggregates

$$c = \frac{V_p}{V} = \frac{38P/C}{100W/C + 38P/C + 32} \quad (\text{Aggregates in concrete})$$

$$A = \frac{1 - c}{1 + c}$$

The composite (concrete) properties is determined in (17) assuming that the aggregate phase is isotropically distributed as stiff, nearly spherical particles in a matrix phase which is an isotropic mixture of basic paste and pores. Stiff means that ag-

gregates have a Young's modulus higher than 2-3 times the Young's modulus of the matrix which is always the case when normal hard aggregates are considered. It comes from (25) that composites of this type have similar creep functions as the matrix. We may then conclude that cement paste has a creep function like the one presented in Equation 5. It is further concluded in (17) that also the basic paste has this type of creep function. Stiffness related properties (E, a) and flow modulus (F), of course, must be properly introduced.

Remarks: The geometry of pores in cement paste is considered by the power used on the A_w -expression in Equation 7. The value 1.8 (default value in this report) applies when the pore system is relatively open as in young concrete. A power value of 1 is more likely in more mature concretes where pore systems are less open.

Unless otherwise indicated Young's moduli subsequently referred to are dynamic moduli. A dynamic modulus (< a few seconds testing time) is a more reliable material property than a static modulus (some minutes testing time) which is influenced by creep, especially at very young material ages.

Reference climate

We maintain at first the reference climatic conditions of (T,RH) \equiv (20°C,100%) previously introduced. At a later stage, however, this restriction is released. After some cumbersome calculations in (17) the results of the composite analysis is that Equation 5 applies with E , a , and F introduced as follows where the reversible creep factor a has been approximated from (17, Eq. 40). F_o is flow modulus of basic paste,

$$\begin{aligned}
 E(\theta) &= 3.2 \cdot 10^4 g(\theta) A_w \frac{g(\theta) A_w A + N}{g(\theta) A_w + AN} \text{ MPa} && \text{Young's modulus} \\
 a(\theta) &= \frac{1 - c}{1 - c(1 - g(\theta) A_w)} && \text{Reversible creep factor} \quad (8) \\
 F &= F_o \frac{A_w}{A} \quad \text{with } F_o \approx 10^4 - 10^5 \text{ MPa} && \text{Flow modulus}
 \end{aligned}$$

$$\begin{aligned}
 N &= \frac{E_p(\text{MPa})}{3.2 \cdot 10^4} && \text{Stiffness ratio} \\
 g(\theta) &= \exp \left(- \left(\frac{t_R}{\theta} \right)^\beta \right) && \text{Degree of hydration with} \\
 &&& t_R \approx \text{hours} ; \beta \approx < 1
 \end{aligned} \quad (9)$$

Relative amount of cement hydrated at age θ is denoted by the so-called degree of hydration $g(\theta)$ which develops as indicated following a suggestion made by Freiesleben (26). E_p is effective Young's modulus of aggregate.

Remark: Effective aggregate Young's modulus is Young's modulus times an efficiency factor γ which considers the influence on aggregate stiffness of defect surface contact to cement paste (such as caused by bleeding). The factor is $\gamma \approx$ fraction of effective aggregate surface divided by total aggregate surface, see (27). A factor of $\gamma = 1$ is default value in this report.

2.2 Creep in general

The influence of temperature on cement paste composition is assumed to follow the concept of maturity (26,28), meaning that the composition at real age t at a temperature history $T(t)$ equals the composition at age t_m (maturity age) at a temperature history of $T \equiv 20^\circ\text{C}$. The procedure of converting real age to maturity age is shown in Equation 10 where the temperature function has been simplified relative the one presented in (26).

$$t_m = \int_0^t L(\tau) d\tau \quad \text{Maturity age} \quad (10)$$

$$L(t) = \left(\frac{T(t)^\circ\text{C} + 15}{35} \right)^{2.4} \quad (0 \text{ if } T < -15^\circ\text{C}) \quad \text{Temperature function}$$

It has been suggested that the influence of climatic conditions on creep of cement paste (and concrete) *at a fixed composition* can be considered by introducing a climate sensitive flow modulus into Equation 6 as explained in the former expression of Equation 11 where f_c is a so-called climate factor which depends on some average of various activation energies involved in the process of creep.

$$F = \frac{F_o A_w}{f_c A} \quad \text{with climate factor } f_c = f_c(T, RH, \text{gradients}) \quad \text{in general} \quad (11)$$

$$f_c = \left(\frac{T^\circ\text{C} + 15}{35} \right)^{1.5} \left(RH_M + 5 \frac{ABS(RH_M - RH)}{1 + 4R} \right) \quad \text{structural member}$$

It is not the intentions of the present report to explain the climate factor in general. Other researchers in the HETEK-project (37,Ph4A) consider this topic. It is, however, of interest in the present context to predict the average of creep in structural

members and internal stresses associated. For this purpose the latter, empirical, expression in Equation 11 has been suggested in (17,18) from inspection of data on the influence of climate on creep compiled by Hilsdorf and Müller in (29) and by Hansen in (30). RH and RH_M are relative humidities on the surface and in the middle respectively of body considered. R is hydraulic radius in meters (volume/surface) of body considered.

It is noticed that rate of creep is predicted to increase in general with increasing temperature and with increasing equilibrium levels of humidity. Creep also increases, however, when differences (positive and negative) appear between internal and external humidity, meaning that both wetting and drying provoke increasing creep (a similar mechanism of both cooling and heating increasing creep has not been included in Equation 11. In the authors opinion we know too little on this feature to do so).

The general creep function for concrete can now be written as follows

$$C(t, \theta) = \frac{1}{E(\theta)} (1 + a(\theta) * \Phi) + \frac{1}{F} \Phi \quad (12)$$

with Young's modulus, reversible creep factor, flow modulus, and reversible creep parameter expressed as follows with maturity ages $t = t_m$ and $\theta = \theta_m$ introduced

$$E(\theta) = 3.2 * 10^4 g(\theta_m) A_w \frac{g(\theta_m) A_w A + N}{g(\theta_m) A_w + AN} \text{ MPa} \quad (13)$$

$$a(\theta) = \frac{1 - c}{1 - c(1 - g(\theta_m) A_w)} ; F = F_o \frac{A_w}{A} ; \Phi = 1 - \left(\frac{\theta_m}{t_m} \right)^p$$

and with the irreversible creep parameter expressed by the following expressions obtained from Equation 6 introducing $t = t_m$, $\theta = \theta_m$, and $dt_m/dt = L(t)$, (temperature function).

$$\Phi = \begin{cases} \int_{\theta_m}^{t_m} \frac{f_c(t)}{L(t) t_m} \left(1 + p \left(\frac{C}{\theta_m} \right)^q \left(\frac{\theta_m}{t_m} \right)^p \right) dt_m & \text{arbitrary climate} \\ \frac{f_c(t)}{L(t)} \left(\log_E \left(\frac{t_m}{\theta_m} \right) + \left(\frac{C}{\theta_m} \right)^q \Phi(t_m, \theta_m) \right) & \text{constant climate} \end{cases} \quad (14)$$

Cement paste and basic paste

Cement paste is concrete with $c = 0$. The concrete expressions reduce as follows with creep parameters from Equations 13 and 14. The expressions reduce further when *basic paste* is considered where $A_w = 1$.

$C(t, \theta) = \frac{1}{E(\theta)}(1 + \Phi) + \frac{1}{F}\phi$	(15)
$E(\theta) = 3.2 \cdot 10^4 A_w g(\theta_m) \text{ MPa}$	<i>Young 's modulus</i>
$F = F_o A_w$	<i>Flow modulus</i>

3. Viscoelastic composite analysis

Stress and strain are considered in this chapter as they develop in concrete subjected to eigenstrain and external stress. As before concrete is considered as a particulate composite with elastic aggregate particles in a viscoelastic cement paste matrix. The stress-strain analysis will be made using the elastic-viscoelastic analogy (ex 1,4,31,32) which, for the present purpose, can be formulated as follows:

The solution to a viscoelastic problem is obtained from its elastic counterpart solution by replacing Young's modulus (of the matrix) with its viscoelastic counterpart operator, which means

$$\frac{1}{E} \Rightarrow \int_0^t C(t,\theta) \frac{d[\]}{d\theta} d\theta \quad \text{or} \quad E \Rightarrow \int_0^t R(t,\theta) \frac{d[\]}{d\theta} d\theta \quad (16)$$

The elastic solutions to problems of interest in this paper are listed in Table 1 based on the authors work on composite materials in (33,34,35,36) assuming that the Poisson's ratio of the matrix has a value between 0.1 and 0.3. As before volume concentration and Young's modulus of aggregates are denoted by c and E_p respectively. Young's modulus of matrix is denoted by E_s . Stiffness ratio is $N = E_p/E_s$. Volumetric eigenstrain of particles, matrix, and composite are denoted by α_p , α_s , and α respectively. Stress is denoted by σ with subscripts P and S for aggregates and matrix respectively.

PROBLEM	ELASTIC SOLUTIONS - PARTICULATE COMPOSITE
Young's modulus	$E = E_s \frac{A + N}{1 + AN}$ with $N = \frac{E_p}{E_s}$ and $A = \frac{1 - c}{1 + c}$
Composite strain caused by external stress σ	$\epsilon = \frac{\sigma}{E_s} \frac{1 + AN}{A + N}$
Internal stress caused by external stress σ	$\sigma_p = \sigma \frac{(1 + A)N}{A + N}$; $\sigma_s = \frac{\sigma - c\sigma_p}{1 - c}$
Eigenstrain/stress caused by particle eigenstrain α_p and matrix eigenstrain α_s	$\alpha = \alpha_s + \Delta\alpha \frac{N(1 - A)}{A + N}$; $\Delta\alpha = \alpha_p - \alpha_s$ $\sigma_p = -K_p \Delta\alpha \frac{A}{A + N}$; $\sigma_s = -\frac{1 - A}{2A} \sigma_p$; ($K_p = E_p/1.8$)
Matrix-stress at spheres	$\sigma_{s,RADIAL} = \sigma_p$; $\sigma_{s,TANGENTIAL} = -\frac{3 - A}{4A} \sigma_p$ (= max $ \sigma_s $)

Table 1. Elastic composite analysis of particulate composite. In eigenstrain/stress analysis: Stresses σ_p and σ_s are hydrostatic ($\sigma_{p,s,kk}/3$), strains (α) are volumetric. K_p is bulk modulus of particles.

The elastic solutions presented in Table 1 and the elastic-viscoelastic analogy are now used in this section to solve eigenstrain/stress problems in particulate composites like concretes. It is assumed that eigenstrain is experienced only by the matrix. This reflects real behavior of concrete subjected to shrinkage. There is, however, no problems in considering particles eigenstrain also such that internal stresses can be determined in concrete subjected to heat or alkali-aggregate reactions. Internal stresses caused by external load are also determined in this section.

As the procedures to follow are straight forward no further comments are made on the analysis. Algorithms for numerical analysis are presented in Appendix C at the end of this report.

3.1 Eigenstrain of composite

Elastic eigenstrain:

$$\alpha = A\alpha_s \frac{N+1}{A+N} \quad \text{or} \quad A\alpha + E_p \frac{\alpha}{E_s} = A \left(\alpha_s + E_p \frac{\alpha_s}{E_s} \right) \quad (17)$$

Viscoelastic eigenstrain:

$$A\alpha + E_p \int_0^t C(t,\theta) \frac{d\alpha}{d\theta} d\theta = A \left(\alpha_s + E_p \int_0^t C(t,\theta) \frac{d\alpha_s}{d\theta} d\theta \right) \quad (18)$$

3.2 Eigenstresses in composite

Elastic particle stress:

$$\sigma_p = K_p \alpha_s \frac{A}{A+N} \quad \text{or} \quad A\sigma_p + \frac{E_p}{E_s} \sigma_p = K_p A \alpha_s \quad ; \quad (K_p = E_p/1.8) \quad (19)$$

Viscoelastic particle stress:

$$A\sigma_p + E_p \int_0^t C(t,\theta) \frac{d\sigma_p}{d\theta} d\theta = K_p A \alpha_s \quad (20)$$

$$\text{Matrix stresses } \sigma_s \text{ and max } \sigma_s \text{ from Table 1} \quad (21)$$

3.3 Stresses in composite subjected to external stress

Elastic particle stress:

$$\sigma_p = \sigma \frac{(1 + A)N}{A + N} \quad \text{or} \quad A\sigma_p + \frac{E_p}{E_s}\sigma_p = (1 + A)\frac{E_p}{E_s}\sigma_o \quad (22)$$

Viscoelastic particle stress:

$$A\sigma_p + E_p \int_0^t C(t, \theta) \frac{d\sigma_p}{d\theta} d\theta = (1 + A)E_p \int_0^t C(t, \theta) \frac{d\sigma}{d\theta} d\theta \quad (23)$$

Viscoelastic particle stress if $\sigma \equiv \sigma_o$ applied at $t = \theta_o$:

$$A\sigma_p + E_p \int_0^t C(t, \theta) \frac{d\sigma_p}{d\theta} d\theta = \sigma_o (1 + A)E_p C(t, \theta_o) H(t - \theta_o) \quad (24)$$

Matrix stress σ_s from Table 1

(25)

Heaviside's step function applied in Equation 24 is $H(x) \equiv 0$ at $x < 0$ and $H(x) \equiv 1$ at $x \geq 0$.

3.4 Composite strain from external load

Elastic composite strain:

$$\varepsilon = \frac{\sigma}{E_s} \frac{1 + AN}{A + N} \quad \text{or} \quad A\varepsilon + \frac{E_p}{E_s}\varepsilon = \frac{1}{E_s}\sigma + \frac{A}{E_s} \frac{E_p}{E_s}\sigma \quad (26)$$

Viscoelastic composite strain

$$A\varepsilon + E_p \int_0^t C(t, \theta) \frac{d\varepsilon}{d\theta} d\theta = Y_1 + Y_2 \quad \text{with} \quad (27)$$

$$Y_1 = \int_0^t C(t, \theta) \frac{d\sigma}{d\theta} d\theta \quad ; \quad Y_2 = AE_p \int_0^t C(t, \theta) \frac{dY_1}{d\theta} d\theta$$

The composite creep function $C(t, \theta_o)$ can be determined as strain ε from Equation 26 with Y_1 and Y_2 expressed as follows with stress $\sigma = H(t - \theta_o)$ introduced. (Heaviside's step function is $H(x) \equiv 0$ at $x < 0$ and $H(x) \equiv 1$ at $x \geq 0$. Dirac's delta function is $\delta(x) = dH(x)/dx$).

$$\begin{aligned} \underline{\sigma} &= H(t - \theta_o) \quad \text{and} \quad \frac{d\sigma}{d\theta} = \delta(t - \theta_o) \quad \Rightarrow \\ Y_1 &= C(t, \theta_o) H(t - \theta_o) \quad ; \quad Y_2 = AE_p \int_{\theta_o}^t C(t, \theta) \frac{dC(\theta, \theta_o)}{d\theta} d\theta \end{aligned} \quad (28)$$

4. HETEK-experiments versus theory

4.1 Introduction

In this chapter results predicted by the methods developed in this paper are compared with results obtained experimentally in research project HETEK (37,Ph2+3) on very young high quality concretes and mortars. We emphasize that it is implicitly assumed at this point that concrete behaves as a linear viscoelastic body - also at very young ages (hours). The relevance of this assumption is discussed at a later stage of this report.

Creep of concrete is considered in Section 4.2, autogeneous shrinkage of mortar and concrete in Section 4.3, and relaxation of concrete in Section 4.4. Only type of experiments and test data are referred to. Any experimental details as well as full descriptions of concrete/mortar compositions used are explained in (37,Ph2). The following extracts from material recipes are of interest in the present context. The abbreviation w% means weight %.

Concrete: $W/C = 0.45$, $P/C = 6.77$ ($P = 3.1$ w% flyash + 0.6 w% solid silica + 96.3 w% sand, gravel, and stones). Average density of P is 2670 kg/m^3 . Volume concentration of P is $c = 0.72$.

Mortar: $W/C = 0.45$, $P/C = 2.11$ ($P = 10.0$ w% flyash + 2.0 w% solid silica + 88.0 w% sand). Average density of P is 2560 kg/m^3 . Volume concentration of P is $c = 0.51$.

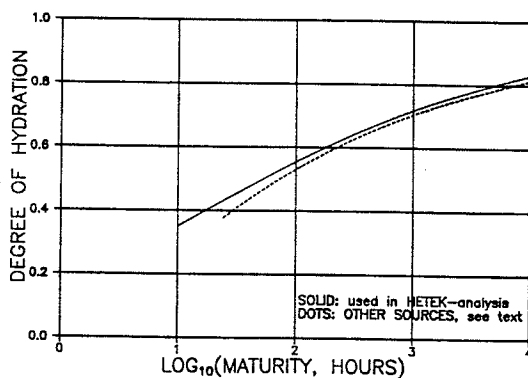

Figure 8. Degree of hydration used in analysis. Other sources compiled in (17).

where an aggregate density of 2600 kg/m^3 is implicitly assumed. The volume concentrations listed above are used in subsequent analysis.

Material parameters used in any analysis subsequently made on HETEK-concrete or HETEK-mortars are summarized in Equation 29. The degree of hydration applied is presented in Figure 8 together with a degree of hydration suggested in (17) as the result of compiling a number of various information on cement hydration

Remark: The solid silica is part of a slurry with equal weight amounts of solid silica and water. The slurry water is included in W/C indicated. Some additives (plastisizers and void producers) were used, the volumes of which are negligible from a composite theoretical point of view. The volume concentrations c listed above differ a little from those (0.76 and 0.51) which can be estimated from Equation 7

(38,39,40). A perfect contact is assumed between aggregates and cement paste, meaning that an efficiency factor of $\gamma = 1$ is assumed, see remark just following Equation 9.

Hydration: $(\beta, t_R) = (0.25, 12h)$ Flow modulus $F_o = 2.2 \cdot 10^4 \text{ MPa}$ Stiffness of aggregate: $E_p = 7.0 \cdot 10^4 \text{ MPa}$ Rate parameters: $(p, q) = (10, 1)$ Consolidation parameter: $C = 50 \text{ hours}$	(29)
--	------

Climatic conditions

The empirical nature of the climate factor f_c presented in Equation 11 is emphasized. Qualitatively the expression describes correctly the influence of climate on creep rates. Quantitatively, however, it has to be verified/calibrated against much more experimental data than those previously referred to.

It is therefor decided to consider only results from HETEK-experiments where the climate factor is approximately 1. This means data from experiments with $T \approx 20^\circ\text{C}$ and $\text{RH} \approx \text{RH}_M \approx 100\%$. In such experiments we include tests on autogeneous shrinkage of mortar and concrete irrespective of knowing that self-desiccation with time may reduce internal humidity with up to about 15%.

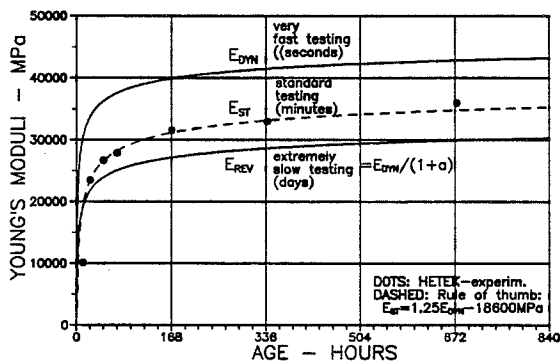

Figure 9. Stiffness moduli for HETEK-concrete defined in this section.

In the author's opinion this decision will have no influence on the main objectives of the present study which are to establish basic rheological parameters for concretes used in practice. To obtain such parameters we must minimize the number of parameters considered. At this point of the present analysis the introduction of more, basically unknown, parameters may act very disturbing - and in

fact very pretentious. Future studies and the results from other projects in the HETEK-programme (37,Ph4A) with variable climatic conditions may modify the results obtained with respect to improved climate factors.

Young's moduli

The Young's modulus $E = E_{DYN}$ for the HETEK concrete just defined is presented in Figure 9 as calculated from Equation 8. The modulus E_{REV} represents total reversible

strain. E_{DYN} and E_{REV} are upper and lower bounds for the static modulus E_{ST} . A well-known rule of thumb tells that E_{ST} is 10% - 20% lower than E_{DYN} . Another rule (british, dashed line in Figure 9) tells that $E_{ST} \approx 1.25E_{DYN} - 18600$ MPa. HETEK Young's moduli are indicated by dots in the figure.

4.2 Deformation of concrete subjected to variable load

Three compressive stress-strain experiments were made at the Danish Technological Institute (DTI) on concrete specimens cured at $(T, RH) = (20^\circ\text{C}, 100\%)$. The specimens were subjected to the load histories explained in Figures 10, 12, and 14. Associated strains were measured as shown in Figures 11, 13, and 15 with dotted lines.

Data predicted by Equation 1 with creep functions from Equation 12 are indicated by solid lines in Figures 11, 13, and 15.

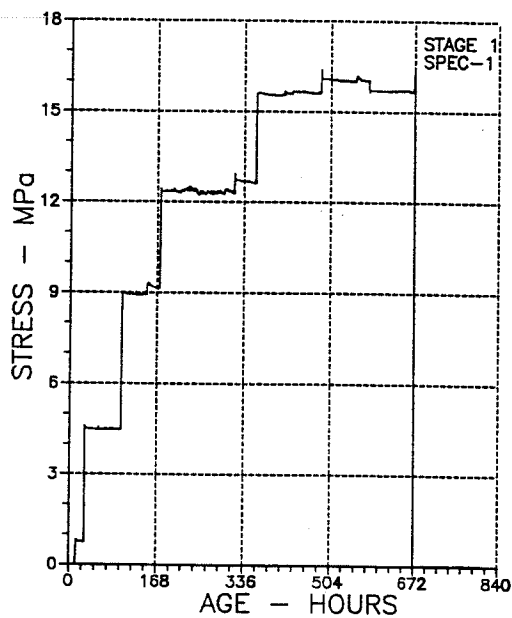

Figure 10. DTI-test st1-spl: Load applied.

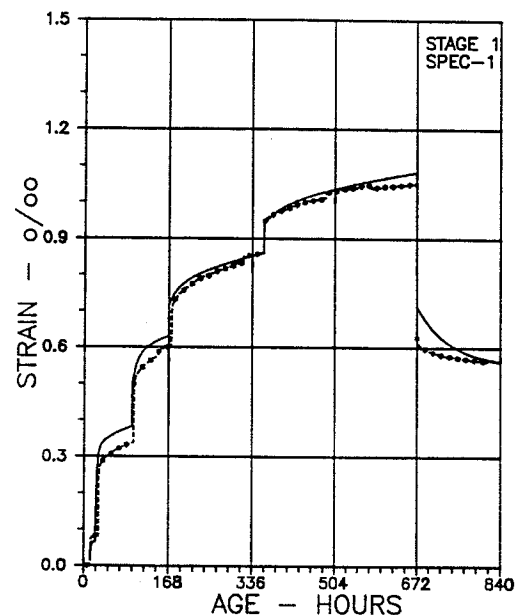

Figure 11. DTI-test st1-spl: Creep strain observed.

Discussion

The positive agreements observed in Figures 11, 13, and 15 between predicted data and experimental results indicate that our implicit assumption of cement paste being a linear viscoelastic material is justified in the periods of ages considered. Thus, previous statements made that concrete behaves linear viscoelastically for ages greater than days can now be modified such that concrete has this kind of behavior down to ages of hours.

This observation is very important - and it is very fortunate. In fact it is probably the most important finding in the HETEK project: It is justified to apply the theory of viscoelasticity in *both structural and composite analysis* of concretes of ages down to about 10 hours.

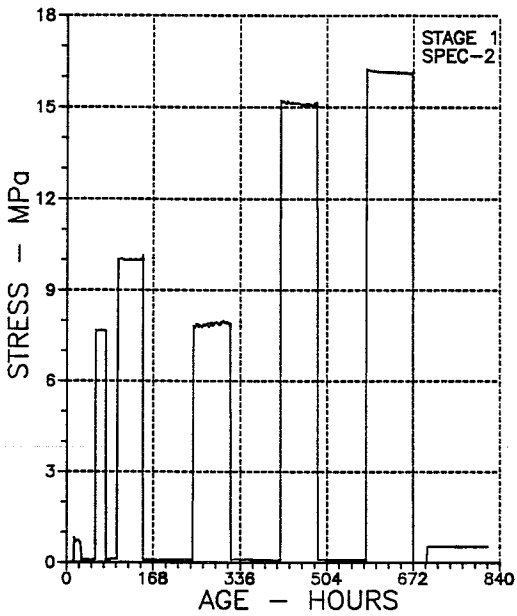

Figure 12. DTI-test st1-sp2: Load applied.

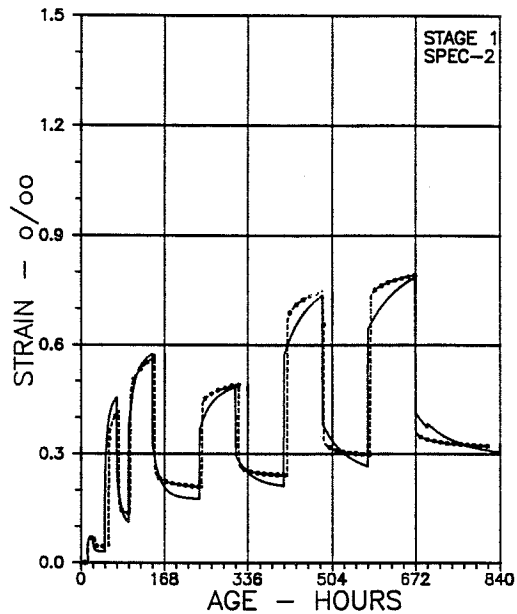

Figure 13. DTI-test st1-sp2: Creep strain observed.

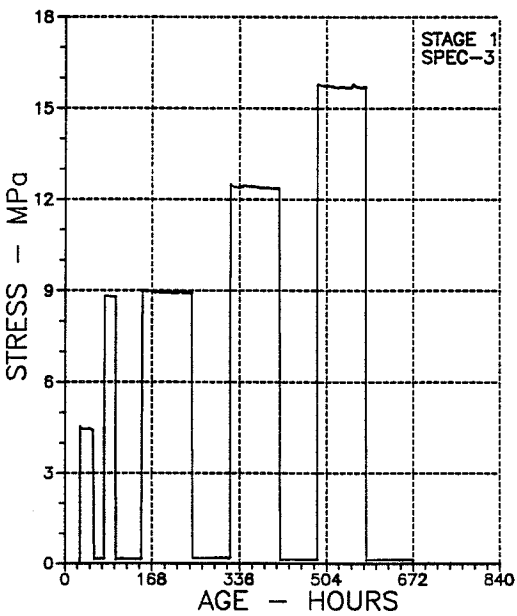

Figure 14. DTI-test st1-sp3: Load applied.

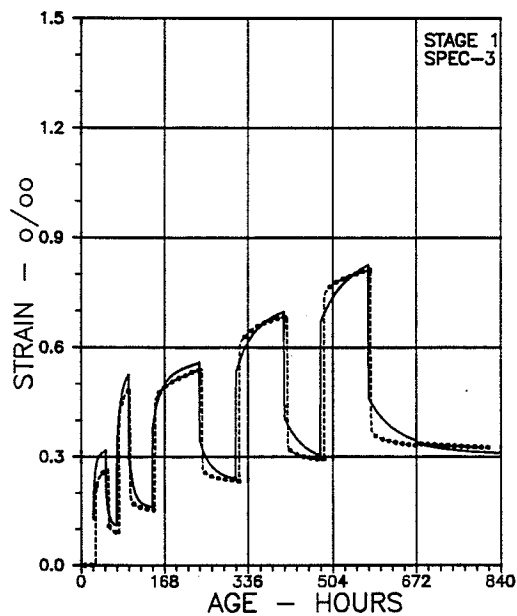

Figure 15. DTI-test st1-sp3: Creep strain observed.

Structural analysis means that structures can be designed considering concrete as a viscoelastic continuum applying the basic Equation 1 with concrete creep function, Equation 12, or with concrete relaxation functions calculated by Equation 2 as demonstrated in Figure 16, (Equation 2 is solved numerically as explained in Appendix C).

Composite analysis means that concrete strain and internal stresses can be calculated as demonstrated in Chapter 3 from knowing the creep function of cement paste as expressed by Equation 15. Such calculations have to be made before any crack risk analysis can be made, whether the concrete is subjected to external load, shrinkage, alkali-aggregate reaction, or heat. A composite analysis is made in subsequent Section 4.3 with special reference to HETEK experiments on the influence of autogenous cement paste shrinkage on mortar and concrete behavior.

Remark: We emphasize that the parameters p , q , and C can be considered constants for the HETEK-cement considered: This feature is very fortunate when it comes to practical creep analysis.

Generalization

The theoretical parameters suspect to changes when other concretes are considered are the cement paste related properties: Degree of hydration $g(t)$, flow modulus F_0 (creep rate), the rate powers p and q , and the consolidation factor C .

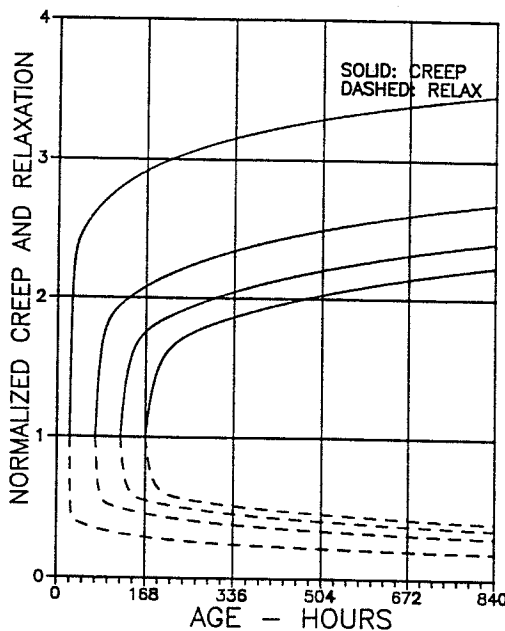

Figure 16. Associated relaxation and creep. Load applications at 1, 3, 5, and 7 days.

The significance of these properties can be explored comparing the results of the method developed in this report with experimental data compiled in the literature on creep tests on mature concretes. In the present context we will limit ourselves only to consider one set of such data. The experimental results indicated by dots in Figure 17 are from L'Hermite et al. (23) as reproduced from a compilation of creep data made by Bazant et al. in (41). The concrete used by L'Hermite et al. is made with $(W/C, P/C, \text{hard aggregates}) = (0.49, 4.8)$ and cured at $(T, RH) = (20^\circ\text{C}, 100\%)$.

The theoretical results indicated by solid lines in Figure 17 are obtained using the same rate parameters (p, q) and consolidation factor (C) as applied in the analysis of HETEK-concrete. A less open pore system of the concrete loaded at $\theta = 730$ days has been considered with an A_w -power of 1, see "Remarks" in Section 2.1. Obviously another cement was used by L'Hermite et al. This is evident from the low $t-\theta$ data in Figure 17 which reflect the Young's modulus variation with age. Furthermore, the creep (flow) rate is lower, meaning that the flow modulus F_o is greater than in the HETEK-concrete. One data set has been excluded in Figure 17 from the test series reported by L'Hermite et al. With load application at $\theta = 365$ days a strain behavior was observed after 600 days which falls completely out of line with results observed with $\theta = 7, 28, 90,$ and 730 days.

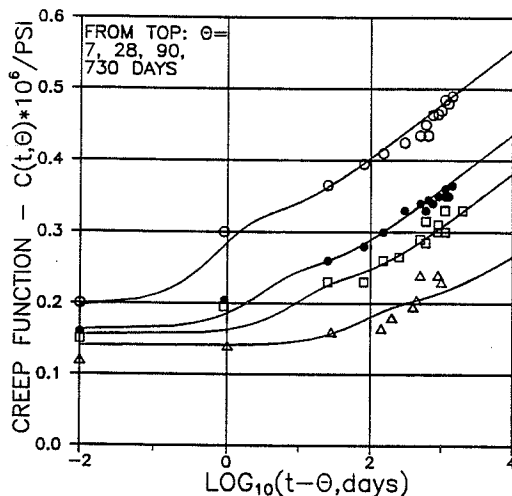

Figure 17. L'Hermite concrete: $(W/C, A/C) = (0.49, 4.8)$, $(\beta, t_R) = (0.9, 80h)$, $F_o = 5.9 \cdot 10^4$ MPa.

Deductions: The agreement between experimental data and theoretical data in Figure 17 is close enough to suggest that the creep descriptions by the theory presented in this report can be generalized to consider any age.

It is worth noticing that the same parameters p , q , and C have been used for both the L'Hermite-concrete and the HETEK-concrete which indicates that *creep of concrete is controlled primarily by hydration properties and flow modulus of the cement type and cement paste applied.*

Notes: The suspicion one might have (from observing that a lower flow modulus applies for the younger HETEK-cement paste than for the older L'Hermite-cement paste) that the flow modulus in general is age dependent cannot be confirmed by the results of L'Hermite covering an age period of more than 1000 days. Furthermore, the statement of an aging flow modulus is contradicted by observations made by other researchers that creep functions for different ages of loading tend to become parallel as time proceeds to long times, see introductory part of Chapter 2.

The influence of cement types on flow modulus is worthwhile studying in a future research project. It is very important in such a project to include studies on the influence of additives and plasticizers (not used by L'Hermite) on decreasing the flow modulus.

4.3 Autogenous shrinkage

Mortar and paste

Autogenous shrinkage of a HETEK-mortar cured at $(T, RH) \equiv (20^\circ\text{C}, 100\%)$ is observed in (37,Ph2) from the age of $t = 0.5$ hour to the age of $t = 320$ hours. The results obtained at the Technical University of Denmark are presented with dots in Figure 18a (blow-up in Figure 18b). Unfortunately no similar results are available for the paste. Such data are needed to predict eigenstrain/stress phenomena such as internal stresses and crack risks in concrete and mortar.

The problem in this section is to deduce the missing information from the mortar tests, and then calculate internal stresses. We can solve the first part of the problem by running the theory (Equation 18 with creep function presented in Equation 15) a number of times with qualified guesses on paste autogenous shrinkage, and then compare the mortar results obtained with the experimental data previously referred to. It is assumed that composite shrinkage is first active at the age t_s where the composite starts solidifying, see Figure 18b. And it is assumed that t_s for paste and mortar are similar.

The results of the procedure just outlined are presented in Figure 19. A convenient mathematical description of the cement paste auto-shrinkage deduced is presented in Equation 30. It comes from (25) that the auto-shrinkage deduced for cement paste is also auto-shrinkage of basic-paste ($W/C = 0.38$). It is noticed from Figure 19 that auto-shrinkage is in fact a swelling from the age of solidification (5 hours).

<i>AUTO-SHRINKAGE OF CEMENT PASTE (ANY W/C ≥ 0.4)</i>	
$\alpha_s = \frac{\alpha_5}{t_5} t$; $t \leq t_5$
$\alpha_s = \alpha_5 + \frac{\alpha_{10} - \alpha_5}{t_{10} - t_5} (t - t_5)$; $t_5 < t \leq t_{10}$
$\alpha_s = \alpha_{10} + \frac{\alpha_{20} - \alpha_{10}}{t_{20} - t_{10}} (t - t_{10})$; $t_{10} < t \leq t_{20}$
$\alpha_s = \alpha_{20} + \frac{\alpha_{300} - \alpha_{20}}{t_{300} - t_{20}} (t - t_{20})$; $t_{20} < t \leq t_{300}$
$\alpha_s \equiv \alpha_{300}$; $t > t_{300}$

$(t_5, \alpha_5) = (5h, -1.245e-2)$, $(t_{10}, \alpha_{10}) = (10h, -1.130e-2)$	
$(t_{20}, \alpha_{20}) = (20h, -1.075e-2)$; $(t_{300}, \alpha_{300}) = (300h, -1.170e-2)$	

Now, when paste shrinkage is deduced internal stresses can be calculated by Equations 20 and 21. Predicted internal stresses are presented in Figure 20. It is noticed that the cement paste stresses start being compressive. The aggregate stress is tensile at the same time. At the age of approximately 130 hours, however, all stresses change their signs.

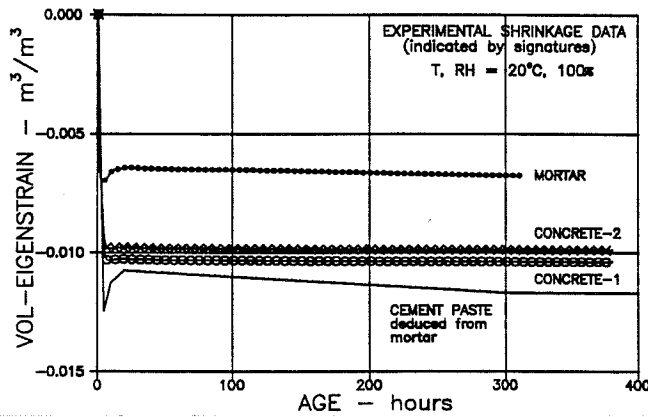

Figure 18a. Symbols: Measured auto-shrinkage of mortar and concrete. Solid line: Cement paste auto-shrinkage deduced from mortar tests.

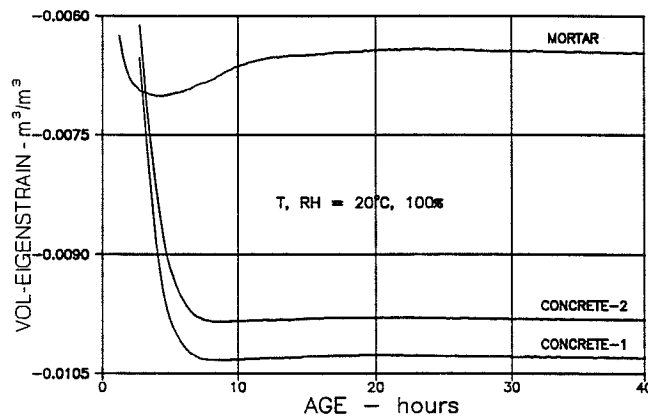

Figure 18b. Blow-up of Figure 18a at low ages. Age at start of solidification t_s is defined at first positive derivative of shrinkage graph. Mortar starts solidifying at $t_s \approx 5$ hours, concrete at $t_s \approx 10$ hours.

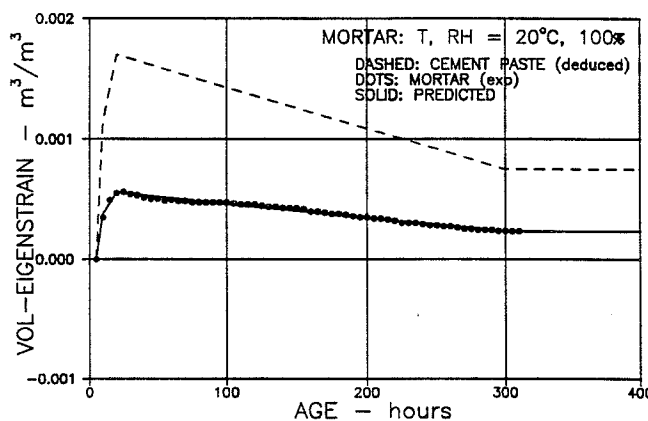

Figure 19. Shrinkage difference of mortar in period, $t_s = 5$ hours (start of solidification) to t .

Remark: It is emphasized that the analysis made above is based on extrapolating cement paste behavior to be linear-viscoelastic down to an age of 5 hours. The results subsequently obtained on concrete will decide if this presumption is reasonable.

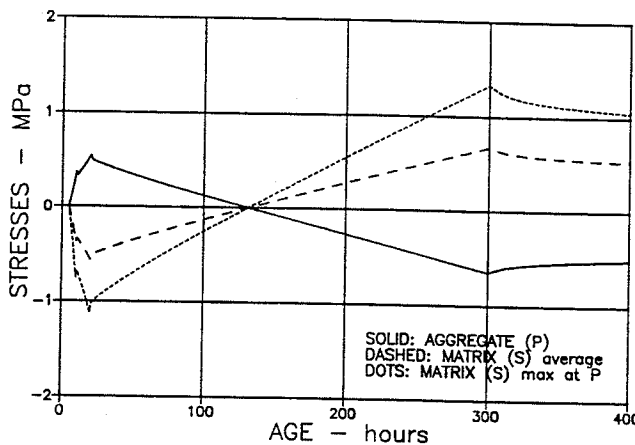

Figure 20. Internal stresses in HETEK-mortar caused by auto-shrinkage. Start of solidification assumed at $t = 5$ h.

Concrete

Autogenous shrinkage of a HETEK-concrete cured at $(T, RH) \equiv (20^\circ\text{C}, 100\%)$ is observed in (37,Ph2) from the age of $t = 1$ hour to the age of $t = 370$ hours. The results obtained at the Technical University of Denmark are presented with cross and circle symbols in Figure 18a (blow-up in Figure 18b). It is noticed that age at start of solidification has been doubled relative to the mortar previously considered. It is believed that this phenomenon is a result of some unknown interaction effect between plasticizer and aggregate surface. The phenomenon which has not been a topic of special studies in the HETEK-project is worth exploring in a future research project. Until then we proceed as follows.

The cement paste shrinkage properties previously deduced are used to predict the concrete shrinkage data shown by lines in Figure 21 and internal concrete stresses shown by lines in Figure 22. The theoretical procedures to follow are just the same as outlined in the previous section - except that we do not first have to deduce the shrinkage properties of the cement paste. It is noticed from Figures 19-22 that mortar and concrete experience strain and internal stresses which are qualitatively alike.

Note: The agreement between experimental data and theoretical data observed in Figure 21 is considered very satisfactory. Apparently the model of analysis worked with (disregarding any mechanism explaining ages of solidification - and approximating cement paste to behave linear-viscoelastically already from the age of 5 hours) can be used to predict shrinkage of concrete with a deviation of less than < 0.00004 (volumetric) ≈ 0.00001 (linear) which is close to accuracy level which can be achieved by measuring technique applied involving clearing of data with respect to temperature deformation of test rig, see (37,Ph2).

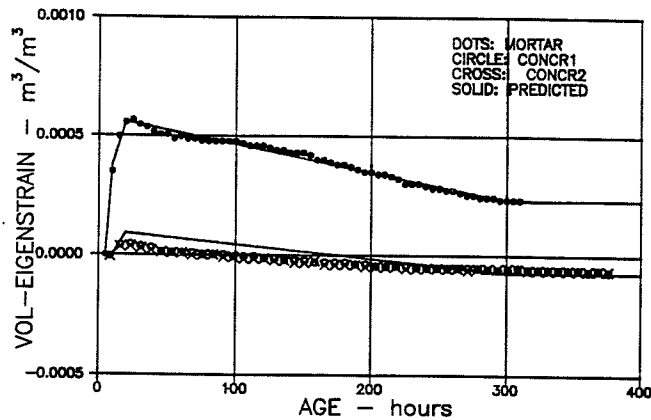

Figure 21. Lower data: Shrinkage difference of concrete in period, age 10 hours (start of concrete solidification) to t . Concretes 1 and 2 almost coincide.

For comparison: Mortar data shown in upper graph are reproduced from Figure 19.

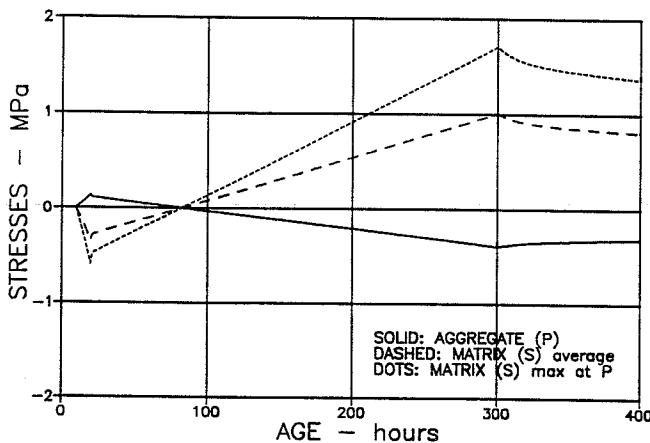

Figure 22. Internal stresses in HETEK-concrete caused by auto-shrinkage. Start of solidification assumed at $t = 10$ h.

Discussion

There is a satisfying agreement in this section between experimental data and theoretical results. Especially when considering that the latter results are basically obtained from a two-fold deduction procedure. First, cement paste creep is deduced from concrete creep experiments. Then, cement paste shrinkage is deduced from cement mortar experiments. Actually, the results of this section present strong evidence indicating that the basic ideas put forward in this report are sound: The HETEK-concretes considered behave viscoelastically as defined by Equations 1 and 12.

This statement has also been confirmed in Section 4.2. From the results of the present section, however, we may further tell that the assumption on balanced creep previously introduced is a reasonable assumption for HETEK-materials. The *simultaneous* agreement observed between experimental shrinkage data and predicted data for both mortar (with $c = 0.51$) and concrete (with $c = 0.72$) could not have been obtained if the assumption was incorrect. Theoretically eigenstrain-stress analysis is a matter of volumetric creep only.

Internal stress - crack risks - strength variation

In the analysis just made on autogeneous shrinkage of mortar and concrete it is noticed that tensile stresses of 1 - 2 MPa develop in the cement paste. Whether this is enough to provoke failure initiation or not can only be decided by a viscoelastic crack mechanical analysis. Such analysis, which has not been made in the HETEK-project, is very much needed in future research projects made to relate strength of concretes (of arbitrary composition) to strength of cement paste.

This section may be considered as a preparatory study to such projects. Further studies are made on internal stresses caused by eigenstrain. Drying shrinkage is considered as an example. Stresses caused by drying shrinkage will become much larger and more dangerous than stresses caused by autogeneous shrinkage. This can easily be shown by Equations 20 and 21 with creep functions from Equation 15. Two examples are subsequently presented on average strain and average-stresses provoked by drying shrinkage. In both examples climate factors are used as explained in Equation 11 (latter expression) and Equation 14.

It is emphasized that the results presented are average values also with respect to changing profiles of humidities. More exact results can be obtained by FEM-analysis introducing the theoretical results referred to in Chapter 3 on eigenstress versus eigenstrain and strain in general versus external load together with more refined (local) climate factors (f_c). It is, however, anticipated that the orders of magnitudes obtained by the approximate average analysis reflect real behavior sufficiently well with respect to general expectations on accuracy considered in Section 1.2.

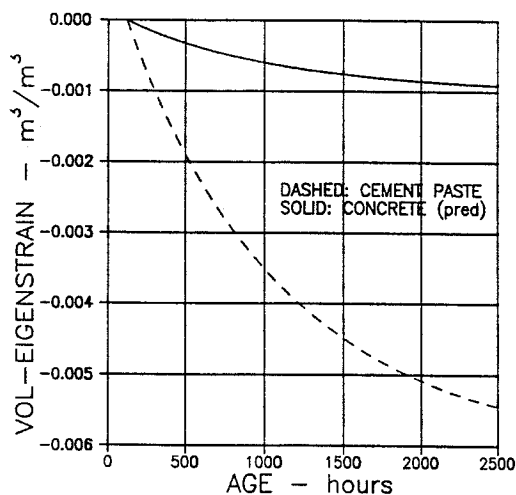

Figure 23. HETEK-concrete exposed to drying at RH = 50 % from the age of 5 days. All data are averages.

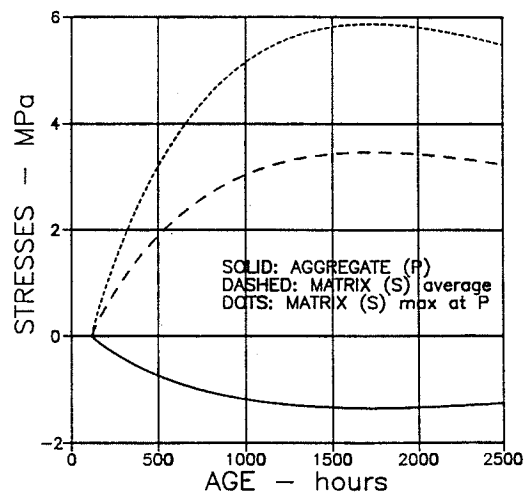

Figure 24. HETEK-concrete exposed to drying at RH = 50 % from the age of 5 days. All data are averages.

Example 1: A HETEK-concrete is exposed to drying at RH = 50% from the age of 5 days, temperature is invariable at T = 20°C. A very modest (volumetric) paste shrinkage of $\alpha_s = -0.006(1-\exp(-(t,\text{hours}-120)/1000))$ is assumed. A structural element is considered with a hydraulic radius of 0.2 m which corresponds, for example, to a high beam of width 0.4 m, or to the approximately 0.2 m outer part of a very thick wall (estimated local surface "hydraulic radius"). The results of analysis are shown in Figures 23 and 24.

Example 2: The coarse aggregate stress in a concrete subjected to drying at RH = 60% from the age of 28 days was observed experimentally by K.E.C. Nielsen in (42). The concrete (LL3) considered by Nielsen is made with a water-cement ratio of W/C = 0.4, a total aggregate concentration of c = 0.7, and no additives. Curing temperature is T = 20°C. Test specimens are cylindrical (Ø 14 cm) with a hydraulic radius of R = 0.035 m. No information on creep of the concrete considered is reported by Nielsen.

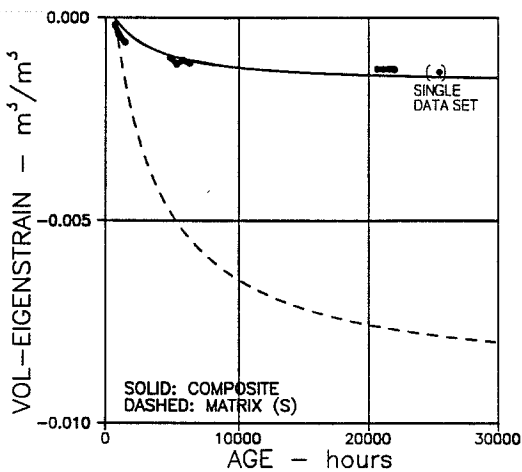

Figure 25. Nielsen-concrete (LL3) exposed to drying at RH = 60 % from the age of 28 days. All predicted data are averages.

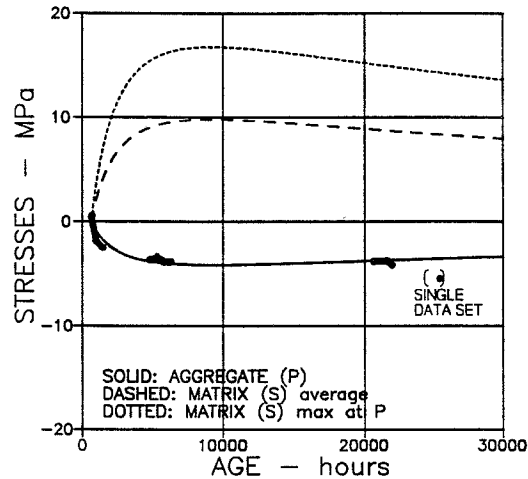

Figure 26. Nielsen-concrete (LL3) exposed to drying at RH = 60 % from the age of 28 days. All predicted data are averages.

The strains and stresses monitored continuously by Nielsen are presented in Figures 25 and 26 by dotted line sections. The theoretical predictions presented in the figures are calculated assuming a creep behavior similar to the L'Hermite-concrete previously considered $(\beta, t_R, F_0) = (0.9, 80h, 5.9 \cdot 10^4 \text{ MPa})$ and $(p, q, C) = (10, 1, 50 \text{ h})$. This assumption is made from guessing that similar normal cement types were probably used by Nielsen and L'Hermite in the years 1965-1971.

A cement paste vol-shrinkage of $\alpha_s = -0.009(t(h) - 672)/(t(h) + 3000)$ is first deduced following the procedures explained in "Mortar and paste" in this Section 4.3. Then

composite stress and strain are determined as previously explained. The results are shown by lines in Figures 25 and 26.

Remark: The *simultaneous agreement* demonstrated in Figures 25 and 26 between experimental and predicted results on strain and stress is a strong justification of the composite-rheological concept of concrete explained in Chapter 2.

Discussion: It is by no means obvious that the HETEK-cement paste can withstand a tensile stress (average) of 6 MPa or that the Nielsen-cement paste can withstand a tensile stress of 17 MPa - superimposed, probably, with internal stresses provoked by heating or structural loads as illustrated in Figure 27 with results calculated as explained in Section 3.3. Once again: It is important that crack mechanical analysis are made in future research projects considering eigenstrain-stress versus strength. Such projects should reproduce the very clever experiments made by Nielsen (42) - implementing modern technology developed in recent years.

It is important to realize that strength of concrete, being a composite material, is not an invariable material property which depends only on degree of hydration. It is a property the potentials of which is highly and negatively influenced by any damage caused by stress concentrations in time before strength is measured - stress concentrations

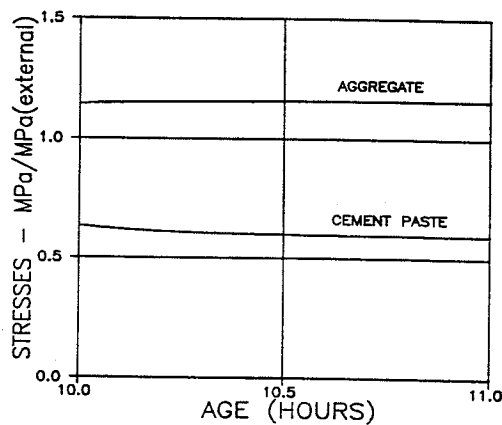

Figure 27. Stresses in HETEK-concrete loaded with 1 MPa at the age of 10 hours. Stresses do not change very much from the age of 11 hours.

caused by eigenstrain-stress effects from shrinkage, fire, and alkali-aggregate reactions for example. It is also a property which depends on time and load history (43).

The argument that "materials exhibiting linear-viscoelastic behavior have no damages" cannot be used in practice to reject the statement that strength is a variable "material property". As in structural wood local damages (knots) play a minor role with respect to stiffness and creep. They have a major influence on strength, however.

Long-time strength of wood is always lower than short-time strength. This is different for concrete (43). Concrete strength will increase with time when the concrete considered is subjected to loads lower than approximately 70% of short-time strength and the concrete structure is not disturbed by additional eigenstrain actions during its lifetime. Concrete strength reduces with time when load is higher than $\approx 70\%$ of short-time strength.

4.4 Relaxation of concrete

Compressive relaxation experiments were made at the Technical University of Denmark on a HETEK-concrete specimen cured at $(T, RH) \equiv (20^\circ\text{C}, 100\%)$. The specimen was subjected at the age of 72 hours to the "constant" strain history indicated by partly coinciding dots in Figure 28. Associated stress was measured as shown in Figure 29, also with partly coinciding dots.

A maximum stress of 8.21 MPa was detected 7 minutes after load application at a strain of $282 \cdot 10^{-6}$ which reveals a Young's modulus of 29000 MPa. For two reasons no immediate theoretical prediction can be made. The strain is not an accurate constant, and the Young's modulus is not dynamic. An approximate prediction, however, can be made in the following way: We estimate $E_{\text{DYN}} = 1.2 \cdot E_{\text{ST}}$ which will simulate a max stress of 10 MPa, 0 minutes after load application. In this way a theoretical relaxation can be predicted by Equation 2 (and Appendix C) as presented by the solid line in Figure 29.

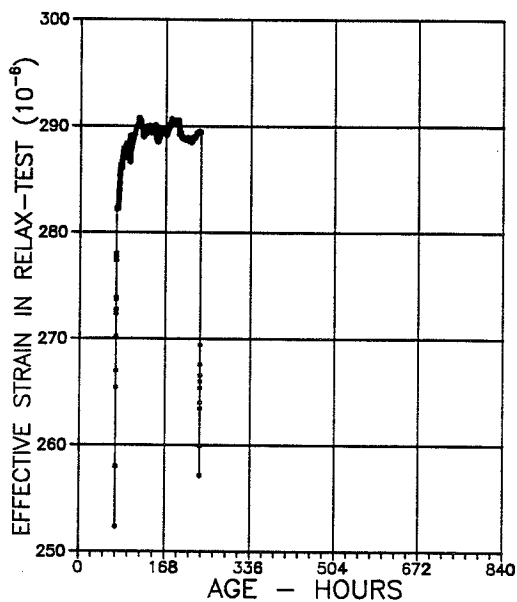

Figure 28. Effective strain in relaxation experiment (cleared with respect to shrinkage).

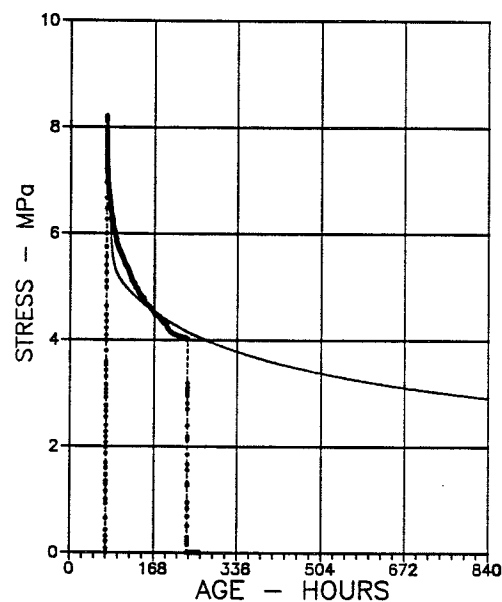

Figure 29. Relaxation: Experimental (partly coinciding dots) and predicted (solid line) as explained in main text.

Discussion

It is emphasized that the relaxation experiments referred to are made with a maximum of accuracy with the technology available (37,Ph3). It is simply not possible within seconds to calibrate strain to hold a precisely constant value from a certain concrete age. The prediction made with estimated dynamic Young's modulus, how-

ver, is quite realistic. It is common knowledge that dynamic moduli are approximately 15-25% higher than static moduli.

It can then be concluded that there is a satisfying agreement between experimentally obtained relaxation data and theoretically predicted data.

5. Conclusions

Composite analysis of concrete: A creep theory for concrete is presented in this report. The theory consistently predicts creep and internal stresses as a function of concrete composition, age at loading, and climatic conditions. No other existing "creep prediction method" offers these possibilities in one approach.

At reference climatic conditions, $(T,RH) = (20^{\circ}\text{C},100\%)$, theoretical predictions on creep, shrinkage, and relaxation of very young concretes (hours) are successfully compared with experimental results obtained in the HETEK-project (37). At similar climatic conditions theoretically predicted creep results agree with data from experiments on mature (weeks) concrete reported in the literature (23). Theoretical prediction of average aggregate stresses caused by shrinkage in mature concrete dried at $(T,RH) = (20^{\circ}\text{C},100\% \rightarrow 60\%)$ agree with results reported in the literature (42).

It seems that the theory presented is general with respect to age at loading. This means that stress-strain analysis of concrete and concrete structures can be made in one continuous approach without introducing separate constitutive relations for early age concrete, young concrete, and mature concrete.

Remark: Climatic conditions different from $(T,RH) = (20^{\circ}\text{C},100\%)$ are considered theoretically modifying the rate of creep by a climate factor (f_c) which can be formulated in two ways: One by which climate effects are considered as an average in structural members such as walls and beams, and one by which these effects are considered locally in a continuum. In this report the former approach is used for applications. The latter formulation is of minor interest in the present context of determining basic rheological properties, and is therefore only discussed in principles. "Local" climate factors are, however, of major interest in Finite Element Analysis (FEM-analysis) of large structures. Other tests are designed in the HETEK-project (37,Ph3+4A) to reveal information on local climate factors.

HETEK-creep experiments: The positive agreements observed between predicted data and experimental results (HETEK) indicate that the cement paste and concrete tested can be considered as linear viscoelastic materials from the age of approximately 10 hours. Previous statements made that concrete behaves linear viscoelastically for ages greater than days can be modified such that concrete has this kind of behavior down to ages of hours.

This observation is very important - and it is very fortunate. In fact it is probably the most important finding in the HETEK project: It is justified to apply the theory of viscoelasticity in both structural and composite analysis of concretes of ages down to about 10 hours.

Structural analysis means that structures can be designed considering concrete as a viscoelastic continuum. Composite analysis means that concrete strain and internal stresses can be calculated considering concrete as a viscoelastic composite material.

HETEK-shrinkage experiments: There is a positive agreement between experimental data and theoretical results. It is stated that the basic ideas put forward in this report are sound: The HETEK-concrete behaves linear-viscoelastically. This has already been concluded from the creep experiments. From the results of the shrinkage experiments, however, we may further tell that the HETEK-concrete considered behaves viscoelastically with general creep described sufficiently well by only one creep function, namely the uni-axial creep function. This means that 3D-analysis (3-dimensional) of structures made of HETEK-concrete can be based on the concept of balanced creep. (It is emphasized that other concretes may behave differently).

HETEK-relaxation experiments: There is a satisfying agreement between experimentally obtained relaxation data and theoretically predicted data. The latter data, however, had to be modified recognizing that accurate relaxation experiments, with technology available today, cannot be made sufficiently fast.

Computer simulated creep tests - FEM: The overall positive agreement demonstrated in this report between theory and experimental data indicates that creep functions needed in Finite Element Analysis (FEM) of structures can be established from computer-simulated experiments based on the theory presented in this report, calibrated by only a few real experiments - supplemented, of course, with known hydration properties of cement used.

The maximum number of parameters to calibrate are four: Flow modulus F_0 , consolidation parameter C , and the rate parameters p and q . An analysis made in Section 4.2 indicates that the three latter parameters can probably be fixed at $C = 50$ hours and $(p,q) = (10,1)$ which leaves only F_0 to be calibrated. It is emphasized, however, that the analysis in Section 4.2 is based on two creep data sets only (HETEK and L'Hermite). Thus, until more evidence on C,p,q is compiled it is recommended to calibrate all four parameters mentioned above.

Calibration experiments at climatic conditions $(T,RH) = (20^\circ\text{C}, 100\%)$ should be designed such that reliable basic rheological properties (*including lateral creep behavior*) of the concrete considered can be deduced and cross-checked a number of times up to an age of at least 10 weeks. Three tests (a test set) are suggested for this purpose: ■ A stepwise increasing stress with total unloading at the end (in principle as demonstrated in Figure 10), ■ a stepwise decreasing stress with unloading at the end,

and ■ a stepwise, randomly varying stress (in principle as demonstrated in Figure 12).

Average step length should be approximately 1 week. Stress must not exceed $\approx 40\%$ of immediate strength. Number of calibration experiments depends on accuracy classification of analysis to be made. For example:

High classification:	2 test sets (10% of design tasks)
Average classification:	1 test set (20% of design tasks)
Normal classification:	0-1 test set (70% of design tasks)

These numbers are suggested assuming that all parameters (F_0, C, p, q) considered above must be calibrated. If experience shows that some parameters can be fixed the number of calibration tests may be reduced.

It is emphasized that calibration tests, theoretically, are needed only when new combinations of cement types, additives, and aggregate properties are met. Basically the computer-simulation technique outlined is based on composite theory, meaning that it is invariable with respect to aggregate content. Catalogues on basic rheological properties for groups of concretes can be made, based on calibration experiments with any aggregate content (mortars or concretes).

It is recommended that the suggestions made above on computer-simulation and calibration experiments should be further studied and discussed in a minor research project with respect to standardized procedures. Obviously, a high priority target in this project is to provide information for practice such that stress-strain analysis of concrete and concrete structures can be made in one approach without introducing separate constitutive relations for early age concrete, young concrete, and mature concrete.

Remark: It is emphasized that calibration experiments are made to produce information on basic rheological parameters. They do not (and shall not) consider the influence on creep of climatic conditions different from $(T, RH) = (20^\circ\text{C}, 100\%)$. In this report such influence is considered theoretically by rate of creep modification as explained in Section 2.2. A climate factor (Equation 11) has been suggested which considers the average effect of climatic changes on creep of structural member sections. Observations made by other researchers in the HETEK-project (37, Ph4A) may help to present more refined "climate factors" to be used in accurate FEM-analysis of more general material sections.

Future research: A number of problems have been identified in this report which should be considered in more details. For example:

- Experimental three dimensional creep analysis of concrete as related to concrete composition.
- Accuracy of structural concrete analysis made assuming balanced creep if such creep behavior is an approximation of true behavior.
- The influence of cement type and plasticizers and other additives on flow modulus (rate of creep, activation energy).
- Activation energy for creep as related to concrete composition (aggregate concentration especially) and general creep behavior (balanced or not balanced creep).
- Strength and formation of cracks as related to internal stresses produced by eigenstrain/stress effects. The phenomenon of time dependent strength should also be considered in this project.
- Experimental analysis on internal stresses versus aggregate content. This project should also consider the phenomenon of age at solidification as influenced by plasticizers and aggregate concentration.
- Reliability in general of material properties deduced from a few uni-axial experiments only. The question of reproducibility should also be considered in this project.
- Finally, most concrete in practice is made with normal or prestressed reinforcement. This feature should not be forgotten in research on concrete rheology. Stress distributions in concrete structures change considerably as the result of reinforcement. A number of research projects can be defined which relate plain concrete research to structural concrete research. In this respect some guidelines can be found in (4,44,45).

Structural analysis: Theoretically the composite results obtained in this report can be implemented directly into the analysis of simple concrete structures keeping the information on internal composite stresses. When large structures, however, are considered with complex shapes such analysis is not practicable. FEM-methods have to be used with "homogeneous" material properties introduced as estimated from composite theory. The stress-strain analysis then becomes an average analysis where important local stress-strain information are lost. *Studies must be made* on how to compensate for these losses. In the author's opinion one way is to use finite elements of sizes greater than approximately 5 times the size of the greatest aggregate used in concrete composition. Then "composite sub-analysis" can be made on critical elements with respect to local stress-strain state.

An example will illustrate this feature: A concrete plate is considered with fixed supports. The cement paste shrinks. Average tensile stresses in the plate can be determined by FEM-analysis (only, however, with concrete shrinkage determined by composite analysis). The lifetime of the plate cannot be evaluated from known short time strength and FEM-stresses calculated. It can, however, from a "composite sub-analysis" combined with a viscoelastic fracture analysis by which the influence of time and load history on strength can be considered.

Appendix A - Generalized viscoelastic models

Non-aging viscoelastic materials are considered in this appendix. In principles, however, the text applies also for aging materials with age dependent material parameters E, η .

It can be shown (e.g. 46) that general mechanical models for viscoelastic materials can be established in two ways as illustrated in Table A1. One general model is a Maxwell model connected in series with a chain of several Kelvin models in series. E denotes momentary stiffness, E_{REV} denotes delayed stiffness and τ denotes relaxation time. The number of Kelvin elements can be finite (N) with creep functions consequently described as shown in Equation A1 - or it can be infinite in which case creep functions can be expressed as shown in Table A1 with continuously distributed Kelvin relaxation times considered by the so-called retardation spectrum, $l = l(\tau)$.

The other general model is a Hooke model connected in parallel with a chain of several Maxwell models in parallel. E denotes momentary stiffness, E_{REL} denotes relaxed (final) stiffness and τ denotes relaxation time. The number of Maxwell elements can be finite (N) with relaxation functions consequently described as shown in Equation A1 - or it can be infinite in which case relaxation functions can be expressed as shown in Table A1 with continuously distributed Maxwell relaxation times considered by the so-called relaxation spectrum, $h = h(\tau)$.

<p style="text-align: center;"> $\sum 1/E_n = 1/E_{REV} \quad \tau_n = \eta_n / E_n$ $\sum E_n = E - E_{REL} \quad \tau_n = \eta_n / E_n$ </p>	
RETARDATION SPECTRUM $l(\tau)$	RELAXATION SPECTRUM $h(\tau)$
$l(\tau)$ with $\int_0^{\infty} \frac{l(\tau)}{\tau} d\tau = \frac{1}{E_{REV}}$	$h(\tau)$ with $\int_0^{\infty} \frac{h(\tau)}{\tau} d\tau = E - E_{REL}$
CREEP FUNCTION $C(t)$	RELAXATION FUNCTION $R(t)$
$\frac{1}{E} + \frac{t}{\eta} + \int_0^{\infty} \frac{l(\tau)}{\tau} \left(1 - \text{EXP}\left(-\frac{t}{\tau}\right) \right) d\tau$	$E_{REL} + \int_0^{\infty} \frac{h(\tau)}{\tau} \text{EXP}\left(-\frac{t}{\tau}\right) d\tau$

Table A1. Generalized mechanical models (analogies) for viscoelastic models. Reproduced from (47).

$$\begin{aligned}
 C(t) &= \frac{1}{E} + \frac{t}{\eta} + \sum_{n=1}^N \frac{1}{E_n} \left(1 - \text{EXP} \left(-\frac{t}{\tau_n} \right) \right) ; \text{ Kelvin chain} \\
 R(t) &= E_{REL} + \sum_{n=1}^N E_n \exp \left(-\frac{t}{\tau_n} \right) ; \text{ Maxwell chain}
 \end{aligned}
 \tag{A1}$$

The results in Equation A1 can be predicted from Table A1 with discrete rheological spectra (retardation, relaxation). Examples are the simple models shown in the main text, Figure 3. Most often the analysis of complex viscoelastic materials can only be made numerically. In this context should be mentioned that useful information on couplings between rheological characteristics of materials can be found in (fx 46,48,49,50).

Appendix B - Multi-axial aspects

In this appendix a very short summary is presented on general creep of isotropic viscoelastic materials as this topic is considered by the author in (fx 8). The appendix is used in the main text, Section 1.2, to demonstrate the concept of balanced creep.

In a normal rectangular 1-2-3 coordinate system the stress-strain relations presented in Equation B1 apply with deviatoric creep function C_G and volumetric creep function C_K . Deviatoric and volumetric stress and strain components are defined in Equation B2 with Kronecker's delta $\delta_{ij} = 1$ if $i = j$ and $\delta_{ij} = 0$ if $i \neq j$.

$$\left. \begin{aligned} e_{ij} &= \int_0^t C_G[t, \theta] \frac{ds_{ij}}{d\theta} d\theta && \text{deviatoric strain} \\ \epsilon_{kk} &= \int_0^t C_K[t, \theta] \frac{d\sigma_{kk}}{d\theta} d\theta && \text{volumetric strain} \end{aligned} \right\} \epsilon_{ij} = e_{ij} + \frac{\delta_{ij}}{3} \epsilon_{kk} \text{ general} \quad (B1)$$

$$\left. \begin{aligned} \text{Deviatoric} & \begin{cases} e_{ij} = \epsilon_{ij} - \delta_{ij} \epsilon_{kk} / 3 & \text{strain} \\ s_{ij} = \sigma_{ij} - \delta_{ij} \sigma_{kk} / 3 & \text{stress} \end{cases} && (i, j = 1, 2, 3) \\ \text{Volumetric} & \begin{cases} \epsilon_{kk} = \epsilon_{11} + \epsilon_{22} + \epsilon_{33} & \text{strain} \\ \sigma_{kk} = \sigma_{11} + \sigma_{22} + \sigma_{33} & \text{stress} \end{cases} \end{aligned} \right\} (B2)$$

Uni-axial stress state: Longitudinal strain [11] and lateral strain [22=33] develop as follows (derived from Equation B1) under a constant uni-axial stress state acting from age θ_0

$$\left. \begin{aligned} \epsilon_{11} &= \frac{\sigma_{11}}{3} (2C_G(t, \theta_0) + C_K(t, \theta_0)) \\ \epsilon_{22} &= \frac{\sigma_{11}}{3} (-C_G(t, \theta_0) + C_K(t, \theta_0)) \end{aligned} \right\} \text{uni-axial stress } \sigma_{11} H(t - \theta_0) \quad (B3)$$

showing that uni-axial creep and "overall" Poisson's ratio develop as presented in Equation B4.

$$\left. \begin{aligned} C(t, \theta_0) &= \frac{1}{3} (2C_G(t, \theta_0) + C_K(t, \theta_0)) && \text{uni-axial creep function} \\ \nu(t, \theta_0) &= -\frac{\epsilon_{22}}{\epsilon_{11}} = \frac{C_G(t, \theta_0) - C_K(t, \theta_0)}{2C_G(t, \theta_0) + C_K(t, \theta_0)} && \text{"overall" Poisson's ratio} \end{aligned} \right\} (B4)$$

Balanced creep: This type of creep is defined when both the deviatoric creep function and the volumetric creep function age in the same way, meaning

$$C_G(t, \theta_o) = \frac{f(t, \theta_o)}{2G(\theta_o)} \quad ; \quad C_K(t, \theta_o) = \frac{f(t, \theta_o)}{3K(\theta_o)} \quad (\text{B5})$$

where $f(t, \theta_o)$ is an aging function. Then Equation B4 reduces as follows

$$\begin{aligned} C(t, \theta_o) &= \frac{f(t, \theta_o)}{E(\theta_o)} \quad \text{with} \quad E(\theta_o) = \frac{9K(\theta_o)G(\theta_o)}{3K(\theta_o) + G(\theta_o)} \\ \nu(t, \theta_o) &\equiv \nu(\theta_o) = \frac{3K(\theta_o) - 2G(\theta_o)}{2(3K(\theta_o) + G(\theta_o))} \end{aligned} \quad (\text{B6})$$

where $K(\theta_o)$, $G(\theta_o)$, $E(\theta_o)$, and $\nu(\theta_o)$ denote bulk modulus, shear modulus, Young's modulus, and Poisson's ratio respectively at age θ_o . It is noticed that the "overall" Poisson's ratio becomes a constant when balanced creep is considered - a constant which equals the (real, initial) Poisson's ratio at age of loading θ_o .

Appendix C - Algorithms

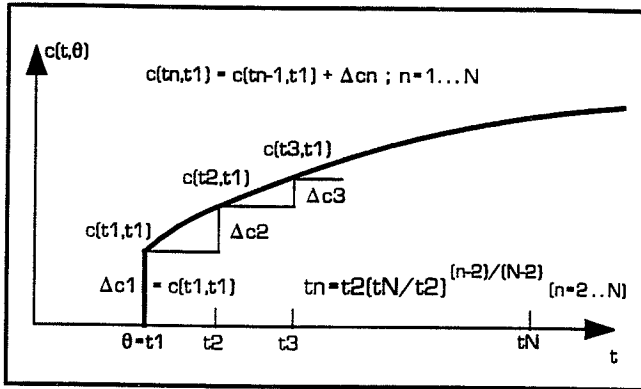

Figure C1. Partitioning of time and creep function for numerical integration.

Some simple algorithms are demonstrated in this appendix by which the composite stress-strain problems described in Chapter 3 and also the creep-relaxation problem in Chapter 1 can be solved numerically. The time partitioning illustrated in Figure C1 is very appropriate in most analysis on composite properties where

stress and strain vary smoothly with monotonically decreasing absolute derivatives. The summations are made with simple step approximation of functions. Number of increments can be reduced by trapeze or smooth approximations. Symbols have the meanings explained in Chapters 1 and 3.

Relax-function from creep function

$$\Delta R_n = \frac{1 - \sum_{i=1}^n \Delta R_i C(t_n, t_i)}{C(t_n, t_n)} ; \quad n \geq 2 \quad (C1)$$

$$\Delta R_1 = R_1 = E(t_1) ; \quad R_n = R_{n-1} + \Delta R_n$$

Eigenstrain of composite

Viscoelastic eigenstrain:

$$A\alpha_{n-1} + A\Delta\alpha_n + E_P \left[\sum_{i=1}^{n-1} \Delta\alpha_i C(t_{n-1}, t_i) + \Delta\alpha_n C(t_n, t_n) \right] =$$

$$A \left(\alpha_{Sn} + E_P \sum_{i=1}^n \Delta\alpha_{Si} C(t_n, t_i) \right) \text{ with } C(t_n, t_n) = 1/E_S(t_n) \Rightarrow \quad (C2)$$

$$\Delta\alpha_n = \frac{A(\alpha_{Sn} - \alpha_{n-1}) - E_P \left[\sum_{i=1}^{n-1} \Delta\alpha_i C(t_{n-1}, t_i) - A \sum_{i=1}^n \Delta\alpha_{Si} C(t_n, t_i) \right]}{A + E_P/E_S(t_n)} \quad (n \geq 2)$$

$$\Delta\alpha_1 = \alpha_1 = 0 , \quad \alpha_n = \alpha_{n-1} + \Delta\alpha_n$$

Eigenstresses in composite*Viscoelastic particle stress:*

$$A\sigma_{P,n-1} + A\Delta\sigma_{P,n} + E_P \sum_{i=1}^{n-1} \Delta\sigma_{P,i} C(t_{n-1}, t_i) + E_P \Delta_{P,n} C(t_n, t_n) = K_P A \alpha_{S,n}$$

$$\Delta_{P,n} = \frac{K_P A \alpha_{S,n} - A\sigma_{P,n-1} - E_P \sum_{i=1}^{n-1} \Delta\sigma_{P,i} C(t_{n-1}, t_i)}{A + E_P / E_S(t_n)} \quad (n \geq 2) \quad (C3)$$

$$\Delta\sigma_{P,1} = \sigma_{P,1} = 0, \quad \sigma_{P,n} = \sigma_{P,n-1} + \Delta\sigma_{P,n}$$

$$\text{Matrix stresses } \sigma_S \text{ and max } \sigma_S \text{ from Table 1} \quad (C4)$$

Stresses in composite subjected to external stress*Viscoelastic particle stress:*

$$A(\sigma_{P,n-1} + \Delta\sigma_{P,n}) + E_P \left[\sum_{i=1}^{n-1} \Delta\sigma_{P,i} C(t_{n-1}, t_i) + \Delta\sigma_{P,n} C(t_n, t_n) \right] = Y \text{ (next scheme)}$$

$$\Delta\sigma_{P,n} = \frac{Y_1 - E_P \sum_{i=1}^{n-1} \Delta_{P,i} C(t_{n-1}, t_i) - A\sigma_{P,n-1}}{A + E_P / E_S(t_n)} \quad n \geq 2 \quad (C5)$$

$$\Delta\sigma_{P,1} = \sigma_{P,1} = \sigma(t_1) \frac{(1+A)N}{A+N} \text{ with } N = \frac{E_P}{E_S(t_1)} ; \quad \sigma_{P,n} = \sigma_{P,n-1} + \Delta\sigma_{P,n}$$

$$Y = \begin{cases} (1+A)E_P \int_0^t C(t, \theta) \frac{d\sigma}{d\theta} d\theta & \text{general } \sigma \\ \sigma_0 (1+A)E_P C(t, \theta_0) H(t - \theta_0) & \text{constant } \sigma = \sigma_0 H(t - \theta_0) \end{cases} \quad (C6)$$

$$\text{Matrix stress } \sigma_S \text{ from Table 1} \quad (C7)$$

Remark: Heaviside's step function is $H(x) \equiv 0$ at $x < 0$ and $H(x) \equiv 1$ at $x \geq 0$.

Composite strain from external stress*Viscoelastic composite strain*

$$A(\varepsilon_{n-1} + \Delta\varepsilon_n) + E_p \left[\sum_{i=1}^{n-1} \Delta\varepsilon_i C(t_{n-1}, t_i) + \Delta\varepsilon_n C(t_n, t_n) \right] = Y_1 + Y_2$$

$$\Delta\varepsilon_n = \frac{Y_1 + Y_2 - E_p \sum_{i=1}^{n-1} \Delta\varepsilon_i C(t_{n-1}, t_i) - A\varepsilon_{n-1}}{A + E_p/E_s(t_n)} \quad (n \geq 2) \quad (C8)$$

$$\varepsilon_1 = \frac{\sigma(t_1)}{E(t_1)} = \frac{\sigma(t_1)}{E_s(t_1)} \frac{1 + AN}{A + N} \quad \text{with } N = \frac{E_p}{E_s(t_1)} \quad \text{and}$$

$$\Delta\varepsilon_1 = \varepsilon_1 \quad ; \quad \varepsilon_n = \varepsilon_{n-1} + \Delta\varepsilon_n$$

Creep function especially

$$\underline{\sigma = \sigma_o H(t - t_1)} \quad ; \quad \frac{d\sigma}{d\tau} = \sigma_o \delta(t - t_1) \quad \Rightarrow$$

$$Y_1 = \sigma_o C(t, t_1) H(t - t_1) \quad \Rightarrow$$

$$Y_2 = \sigma_o A E_p \int_{t_1}^t C(t, \theta) \frac{dC(\theta, t_1)}{d\theta} d\theta = \sigma_o A E_p \sum_{i=1}^n C(t_n, t_i) \Delta C$$

$$\Delta C = C(t_i, t_1) - C(t_{i-1}, t_1) \quad ; \quad (\text{OBS: } C(t_{1-1}, t_1) = 0)$$

List of notations

The symbols most frequently used in this report are listed below. Whenever needed to distinguish phase properties from composite (mortar or concrete) properties subscripts P and S refer to phase P (aggregates) and phase S (cement paste or mortar) properties respectively while composite properties are not subscripted. Local symbols used only in intermediate results or closed sections are not listed. Uni-axial properties are referred to unless otherwise indicated.

	Subscripts
P, S	Phase P (aggregates) and phase S (paste or mortar)
REV	Reversible
IRREV	Irreversible
LONG	Longitudinal
PERP	Perpendicular
DYN	Dynamic
ST	Static
o	Basic paste, reference age at loading
	Time and climate
t	Age
θ	Age at loading
t_s	Age at start of solidification
T	Temperature
t_m, θ_m	Maturity ages
L(t)	Temperature function
g(t)	Degree of hydration
t_R, β	Time parameter and power factor in g(t) expression
RH	Relative humidity
f_c	Climate factor
R	Hydraulic radius = volume/surface (m) of structural element
	Concrete
W/C	Water-cement weight ratio
P/C	Aggregate-cement weight ratio
	Composition
c	Volume concentration of phase P in composite
$A = (1 - c)/1 + c$	Aggregate concentration parameter
c_w	Vol-concentration of capillary pores in fully hydrated cement paste
$A_w = (1 - c_w)/(1 + c_w)^{1.8}$	Pore concentration parameter

	Elasticity
$K = K(t)$	Bulk modulus
$G = G(t)$	Shear modulus
$E = E(t)$	Young's modulus
$\nu = \nu(t)$	Poisson's ratio
$\nu_{CR} = \nu_{CR}(t, \theta)$	Creep Poisson's ratio
$N = N(t) = E_p/E_s$	Stiffness ratio
γ	Efficiency factor (bonding between P and S)
	Viscoelasticity
$C(t, \theta)$	Creep function
$R(t, \theta)$	Relaxation function
η	Viscosity
τ	Relaxation time
F	Flow modulus
$\Phi(t, \theta)$	Developing function (from 0 to 1)
$\phi(t, \theta)$	Creep parameter
$a = a(t)$	Reversible creep factor
C	Consolidation parameter
$p_k(t), q_k(t)$	Age dependent material properties
p, q	Rate powers
$C_G(t, \theta)$	Shear creep function
$C_K(t, \theta)$	Bulk creep function
	Stress and strain
σ	Stress
ε	Strain
α	Volumetric eigenstrain
	Others
$h(t, \theta)$	Relatively "fast" function developing from 0 to 1
$H(t)$	Heaviside's step function, $H(t < 0) \equiv 0$, $H(t \geq 0) \equiv 1$
$\delta(t) = dH(t)/dt$	Dirac's delta function

Literature

1. McHenry, D.: "A new aspect of creep in concrete and its application to design", Proc. ASTM 43(1943), 1069-1084.
2. Dischinger, F.: "Untersuchungen über die Knicksicherheit, die elastische Verformung und das Kriechen des Betons bei Bogenbrücken", Bauingenieur 1937, 487-520, 539-552, 595-621.
3. *Idem*: "Elastische und plastische Verformungen der Eisenbetontragwerke und insbesondere der Bogenbrücken", Bauingenieur 1939, 53-63, 286-294, 426-437, 563-572.
4. Nielsen, L. Fuglsang: "Effects of creep in uncracked composite structures of steel and concrete". Bygningstatiske Meddelelser, 38(1967), 65-88.
5. Ross, A.D.: "Experiments on the creep of concrete under two-dimensional stressing", ACI Journ., 9(1958), 739.
6. Duke, C.M. and Davis, H.E.: "Some properties of concrete under sustained combined stresses", ASTM Proc. 44(1944), 888.
7. Nielsen, L. Fuglsang: "Creep of Plain Concrete", Nordisk Beton 10(1966), 141, (in danish with english summary). Also: The International Conference on the Structure of Concrete, London 1965, Proc. Cement and Concrete Association, London (1968), 306.
8. *Idem*: "New Methods in Practical creep Analysis of Concrete", Seventh Int. Congr. on Rheology, Gothenburg, Sweden 1976. Proc. Chalmers Univ. of Technology, Gothenburg (1976), 98.
9. *Idem*: "Creep of Concrete under a Multi-Axial State of Stress", Fifth Int. Congr. on Rheology, Kyoto, Japan 1968, Proc. Vol. II, 527, University of Tokyo Press 1970.
10. Hummel, A., Karlhans, W., Brand, W., Rüsich, H., Kordina, K., and Hilsdorf, H.: "Versuche über das Kriechen unbewehrten Betons", Deutscher Ausschuss für Stahlbeton, 146(1962).
11. Illston, J.M.: "The components of strain in concrete under sustained compressive stress", Mag. Concr. Res., 17(1965), 21-28.
12. Glücklich I. and Ishai O.: "Rheological behavior of hardened cement paste under low stresses", ACI Journ., Proceedings 57(1961), 947-964.
13. Nielsen, L. Fuglsang: "Kriechen und Relaxation des Betons", Beton- und Stahlbetonbau, 65(1970), 272-275.
14. *Idem*: "Constitutive equations for concrete", Bygningstatiske Meddelelser, 45(1974), 65-87.
15. *Idem*: "On the applicability of modified Dischinger equations", Cem. and Concr. Res., 7(1977), 149-160.
16. *Idem*: "The improved Dischinger method as related to other methods and practical applicability", Special Publication of the American Concrete Institute, SP-76(1982), 169-191.
17. *Idem*: "On the prediction of rheological parameters for concrete", Nordic Seminar on Deformations in Concrete Structures, Copenhagen, march 1980, pp 81-118 in Proc. edited by Gunnar Mohr, DIALOG 1-80, Danish Engineering Academy, Copenhagen, 1980.

18. *Idem*: "Creep and Stiffness of Concrete - a rational prediction method", (in danish with eng. summary). Dansk Beton 4(1992).
19. *Idem*: "On the Prediction of Creep Functions for Concrete", in "Fundamental Research on Creep and Shrinkage of Concrete" (ed. F. Wittmann), Martinus Nijhoff Publishers, The Hague 1982, 279 - 289.
20. Hanson, G.E., Raphael, J.M. and Davies R.E., ASTM Proceedings 58(1958), 1101.
21. Hanson, J.A.: "A 10-year study of creep properties of concrete", U.S. Dept. of the Interior, Design, and Construction Division, Denver, Colerado, Concrete Lab. Report SP-38(1953).
22. Hansen, T.C.: "Creep and stress relaxation of concrete", Handlingar, 31(1960), Tech. Univ. Stockholm.
23. L'Hermite, R.L., Mamillan, M. and Lefèvre, C.: "New results on the strain and failure of concrete", L'Institut Technique du Batiment et des Travaux Publics, Annales 18(1965), 323.
24. Powers, T.C. and Brownyard, T.L.: "Studies of the physical properties of hardened cement paste", ACI Journ., Proceedings 41(1946-1947), 101, 249, 469, 549, 669, 845, 865, 933, 971.
25. Nielsen, L. Fuglsang: "Rheologische Eigenschaften für linear-viskoelastische Kompositmaterialien", Cem. Concr. Res., 3(1973), 751-766.
26. Hansen, P. Freiesleben: "Hærdeteknologi-1, Portland cement" og "Hærdeteknologi-2, Dekrementmetoden", Bkf-centralen, 1978.
27. Nielsen, L. Fuglsang: "On the effect of defective phase contact on the mechanical behavior of particulate composites like concrete", Cement and Concrete Res., 12(1982), 685.
28. Hansen, P. Freiesleben and Pedersen, E.J.: "Vinterstøbning af beton", Statens Byggeforskningsinstitut, SBI-anvisning 125(1982).
29. Hilsdorf, H.K. and Müller, H.S.: "Comparison of methods to predict time dependent strains of concrete", Institut für Baustofftechnologie, Universität Karlsruhe (TU), 1979.
30. Hansen, T.C.: "Creep and stress relaxation of concrete", Swedish Cement and Concrete Research Institute, Bulletin, 31(1960), Stockholm.
31. Alfrey, T.: "Non-Homogeneous Stresses in Viscoelastic Media". Qu. Appl. Math. 2(1944), 113.
32. Lee, E.H.: "Stress analysis in viscoelastic bodies". Quarterly of Appl. Mathematics, 13(1955), 183
33. Nielsen, L. Fuglsang: "Rheologische Eigenschaften für isotrope linear-viscoelastische Kompositmaterialien", Cement and Concrete Research, 3(1973), 751 - 766.
34. *Idem*: "Interne Spannungen sowie Schwind- und Temperaturdeformationen des Betons", Cement and Concrete Research, 4(1974), 31 - 44.
35. *Idem*: "Mechanics of composite material subjected to eigenstress - With special

- reference to frost resistance of porous brittle material", Danish Building Research Institute, SBI-Bulletin 96(1993).
36. *Idem*: "Kuglearmerede og porøse materialer under volumetriske påvirkninger", (in danish, Particulate composites and porous materials subjected to eigenstrain), Tech. report 340(1995), Build. Mat. Lab., Tech. Univ. Denmark.
37. Danish Road Directorate: "Control of Early Age Cracking", Part 3 of a major research programme on "High Performance Concrete - The Contractor's Technology (HETEK)" coordinated by the Danish Road Directorate, Copenhagen, Denmark, 1997.
- 37,Ph1 *"State of the Art" (Phase 1)*: Pedersen, E. Steen, H. Spange, E. J. Pedersen, A. Boe Hauggaard, J. Hougaard Hansen, O. Mejlhede Jensen, and B. Friis Dela.
 - 37,Ph2 *"Shrinkage of Mortar and Concrete" (Phase 2)*: Jensen, O. Mejlhede, S. Lolk Christensen, B. Friis Dela, J. Hougaard Hansen, P. Freiesleben Hansen, and A. Nielsen.
 - 37,Ph3 *"Creep in Concrete" (Phase 3)*: Hauggaard, A. Boe, L. Damkilde, P. Freiesleben Hansen, J. Hougaard Hansen, and A. Nielsen.
 - 37,Ph4A *"Material modelling - Continuum Approach" (Phase 4A)*: Hauggaard, A. Boe, L. Damkilde, P. Freiesleben Hansen, E. Steen Pedersen, and A. Nielsen.
 - 37,Ph4B *"Material modelling - Composite Approach" (Phase 4B)*: Nielsen, L. Fuglsang.
38. Ahlgren, L., Bergström, S.G., Fagerlund, G., and Nielson, L.O.: "Moisture in concrete", Cement och Betong Institutet, Stockholm, 1976.
39. Diamond, S.: "Pore structure of hardened cement paste as influenced by hydration temperature", RILEM/IUPAC, Prag, Vol. I(1973), B-73.
40. Sellevold, E.: Private communication, Build. Mat. Lab, Tech. Univ. Denmark, 1979.
41. Bazant, Z.P. and Osman, E., Cement and Concrete Res., 5(1975), 129, 635.
42. Nielsen, Knud E.C.: "Aggregate stresses in concrete", Thesis, Proceedings 41(1971), Swedish Cement and Concrete Research Institute, Royal Institute of Technology, Stockholm.
43. Nielsen, L. Fuglsang: "Træthed og reststyrke i beton" (in danish, Fatigue and residual strength of concrete), Report R-7(1996), Dept. Struct. Engineering and Materials, Tech. Univ. Denmark.
44. *Idem*: "On the Rheology of Reinforced Concrete - with Particular Reference to Creep Deflection of Beams", Fifth Int. Congr. on Rheology, Kyoto, Japan 1968, Proc. Vol. II, 513, University of Tokyo Press 1970. (Co-author E. Poulsen).
45. *Idem*: "Einfluss des Kriechens und Schwindens auf die Moment-Krümmungs Beziehung des Stahlbetons - insbesondere im gerissenen Zustand", Acta Polytechnica Scandinavica, Ci76(1973).
46. Nowick, A.S., and Berry, B.S.: "Anelastic relaxation in crystalline solids", Academic Press, New York, 1972.
47. Nielsen, L. Fuglsang: "Materialemechanik II - Rheologi, Brud, Kompositmaterialer

og Levetid", (in danish, Material mechanics II - Rheology, Damage, Composites, and Fatigue), Textbook (TR-189), Build. Mat, Lab., Techn. Univ. Denmark, 1988.

48. Leaderman, H.: "Viscoelastic phenomena in amorphous high polymeric systems", Chapter 1 in Eirich, F. (ed): "Rheology", Vol. II, Academic Press Inc., New York, 1958.

49. Schwarzl, F.R.: "Numerical calculation of stress relaxation modulus from dynamic data for linear viscoelastic materials", Rheologica Acta, 14(1975), pp 581-590.

50. Nielsen, L. Fuglsang: "Power Law Creep as Related to Relaxation, Elasticity, Damping, Rheological Spectra and Creep Recovery - With Special Reference to Wood", Conference of Int. Union of Forestry Research Organizations (IUFRO), Xalapa, Mexico, December 1984. Proc., Build. Mat. Lab., Techn. Univ. Denmark 1985, 181 - 204.